



EUROCOPTER
AS365 N3

Technical
Data



helicopters you can count on

365 N3 06.101.02 E

DAUPHIN
(Civil Version)



AS 365 N3

PANTHER
(Military version)



Utility/armed version
AS 565 UB



Naval version
AS 565 M B

Contents

1 – Foreword	3
2 - General characteristics	4
3 - Standard Aircraft Definition	12
4 - Optional equipment	14
5 - Table of Constraints	21
6 - Main performance	35

Manufacturers notice

Attention !

EUROCOPTER, *its logo*, AS365 N3, DAUPHIN, FENESTRON, STARFLEX, are trade marks of the Eurocopter group.

Eurocopter's policy is one of on-going product enhancement which means that alterations in definition, pictures, weights, dimensions or performance may be made at any time without notice being included in those documents that have already been issued.

This document cannot thus be taken as an offer or serve as an appendix to a contract without a prior check as to its validity and prior written agreement of EUROCOPTER.

The operational or certification regulations, as defined by the local authorities, can make compulsory the installation of some of the equipment or recommended solutions, listed in this document. This list does not claim to cover the whole of the worldwide operational requirements nor the equipment not specifically related to the helicopter (for example: life jacket) or necessary for particular missions (for example: supplemental oxygen). The operator is responsible for ascertaining with his local authorities that the planned configuration of the helicopter complies with regulatory requirements for the area(s) of operations and the type(s) of mission(s) considered.

The data set forth in this document are general in nature and for information purposes only.

For performance data and operating limitations, reference must be made to the approved flight manual and all appropriate documents.

Blank

The data set forth in this document are general in nature and for information purposes only.

For performance data and operating limitations, reference must be made to the approved flight manual and all appropriate documents.

1- Foreword



The AS365 N3 is a medium twin engine helicopter of 4,300 kg Maximum Take-Off Weight with outstanding performance that belongs to the famous AS365 family. Over 828 units, with total flight hours in excess of 3 886 000, have been delivered to date.

The AS365 N3 is a multirole powerful and fast helicopter with long range capabilities particularly well adapted for operations in high altitude and hot countries thanks to its two Turbomeca ARRIEL 2C turbine engines fitted with Full Authority Digital Engine Control System (FADEC). It has a very large useful volume and will accommodate various seating arrangements up to 12 passengers and 2 crew members in a spacious cabin.

Technical advancements developed by EUROCOPTER on the AS365 N3 include modular design of the mechanical assemblies, use of composite materials (STARFLEX rotor head, blades, airframe, ...) which has led to significant maintenance reduction.

The AS365 N3 also incorporates the new generation, all composite FENESTRON tail rotor that provides high manoeuvrability, exceptional efficiency at all speeds, low noise level and maximum safety.

EUROCOPTER improves continuously each helicopter of its range, taking benefit from the field experience of several hundred Customers operating daily worldwide. In 2006 some significant proven equipment are implemented in the standard AS365 N3: PFD & ND Multifunction Displays replacing the electromechanical instruments, a fuzz burner on engines lubrication system and improved anti corrosion protection.

EUROCOPTER knows only too well that the majority of the costs of ownership are realized over the operational life of the helicopter. Indeed, as much as 60% of the life cycle costs occur during the in-service phase. For this reason, reliability, maintainability and supportability are the cornerstones of the design of all EUROCOPTER products.

The basic vehicle design for AS365 N3 is based on the concept of Reliability Centered Maintenance and, as such, embodies a modern concept of dynamic assemblies and systems, use of composite materials, redundant systems and unlimited service life of main components.

The AS365 N3 possesses “designed-in maintainability” with numerous interchangeable parts that can be replaced quickly to facilitate ease of maintenance. The main components (engines, main rotor head, main gearbox) have a modular design and are directly accessible, with minimum requirements to remove other components of the aircraft.

The data set forth in this document are general in nature and for information purposes only.

For performance data and operating limitations, reference must be made to the approved flight manual and all appropriate documents.

2- General Characteristics

Lay-Out

- **Passenger transport**
 - 1 or 2 pilots + 8 passengers with standard seat layout
 - 1 or 2 pilots + 11 passengers with optional seat layout
 - 1 or 2 pilots + 12 passengers with optional seat layout
- **Casualty transport**
 - 1 or 2 pilots + 4 stretcher-patients + 1 seat for medical attendant (or 2 stretcher-patients and 4 seats)

Weights

Note: Empty weight accuracy: within $\pm 2\%$

	kg	lb
■ Empty weight, standard aircraft (including engine oil and unusable fuel)	2,389	5,267
■ Useful load	1,911	4,213
■ Maximum all-up weight	4,300	9,480
■ Maximum cargo-sling load	1,600	3,527
■ Maximum all-up weight in external load configuration	4,300	9,480

Power plant: 2 Turbomeca ARRIEL 2C free turbine engines

Note: Thermal power, ISA, Sea Level

	kW	ch	shp
■ O.E.I. 30 seconds rating	729	990	977
■ OE.I. 2 minutes rating	656	891	879
■ Continuous O.E.I. rating	635	863	851
■ Take-Off Power	635	863	851
■ Maximum Continuous Power	597	811	800

Usable Fuel capacities

	litres	US gal.	kg	lb
■ Standard fuel tanks (2 groups)	1,135	300	897	1,977
■ Additional fuel tanks				
● Auxiliary fuel tank	180	47	142	313
● Ferrying fuel tank	460	121	363	801

The data set forth in this document are general in nature and for information purposes only.

For performance data and operating limitations, reference must be made to the approved flight manual and all appropriate documents.

Main dimensions

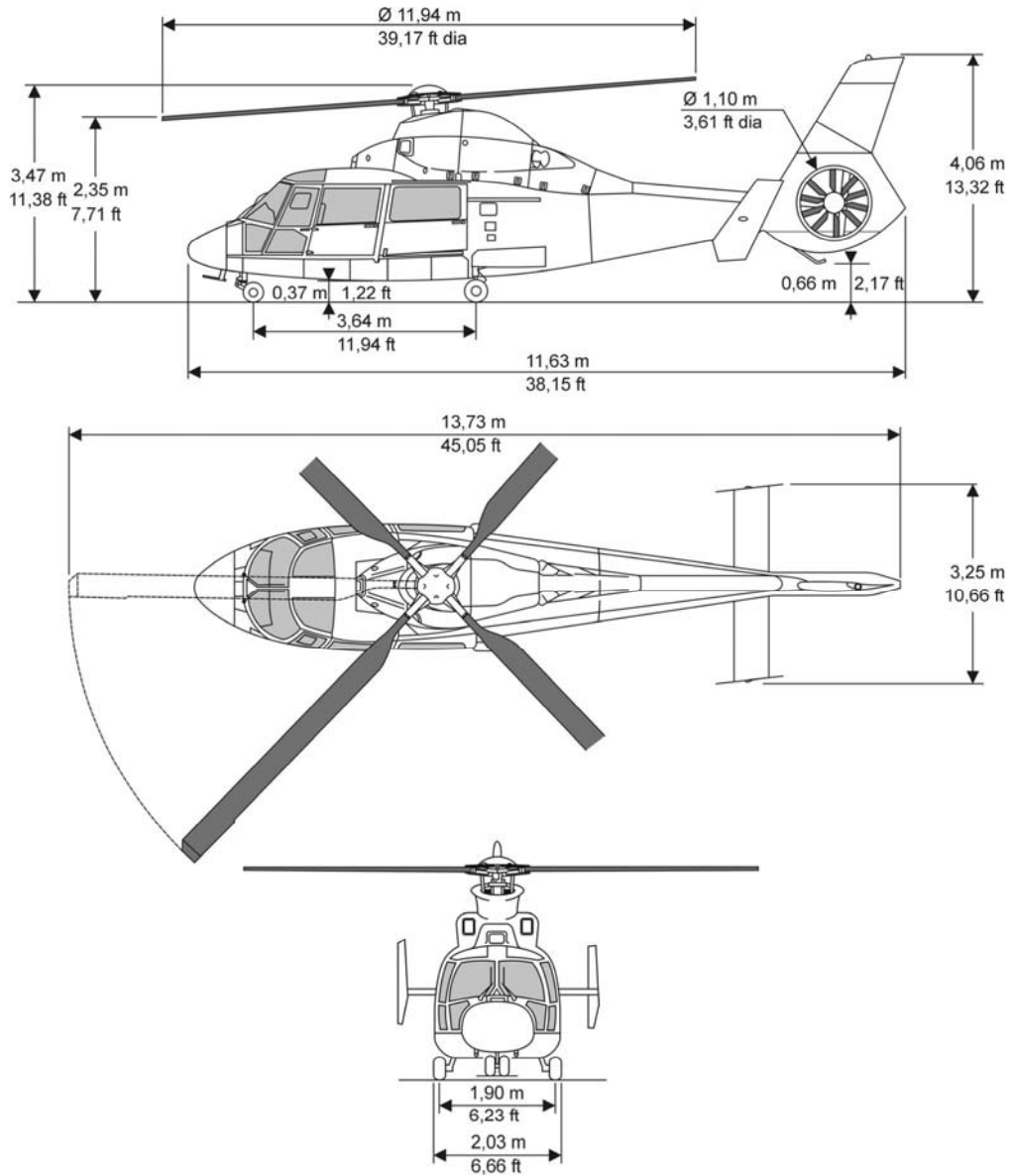

Dimensions with blades folded

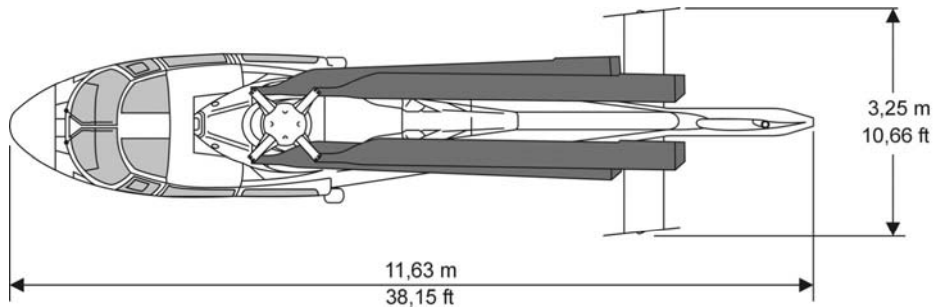

The data set forth in this document are general in nature and for information purposes only.

For performance data and operating limitations, reference must be made to the approved flight manual and all appropriate documents.

Standard 8-seat configuration

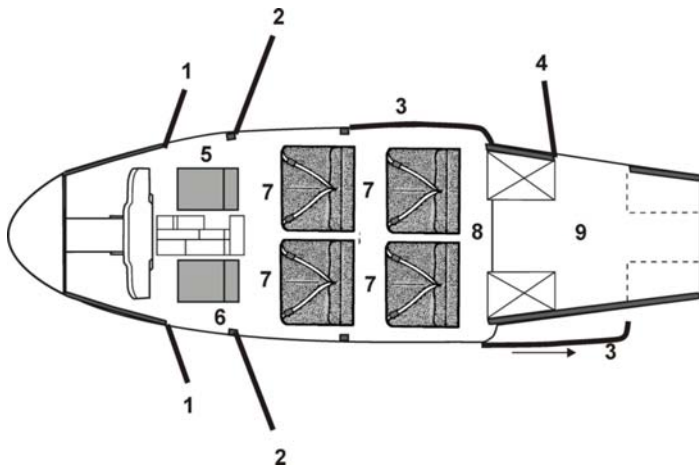

- | | |
|-------------------------------|-----------------------------------|
| 1 - Access to the cockpit | 6 - Passenger's or copilot's seat |
| 2 - Access to the front seats | 7 - Passenger seats |
| 3 - Access to the rear seats | 8 - Spare space for cabin luggage |
| 4 - Luggage hold door | 9 - Luggage hold |
| 5 - Pilot's seat | |

The cockpit is fitted with 2 high back-rest seats each with safety belt and inertia-reel harness for the pilot on the RH side and for the co-pilot on the LH side. These crew seats are adjustable fore-and-aft and in height.

The cabin is fitted with 8 seats in 2 rows (with 3-point harnesses).

Alternate Cabin Configurations (Optional Equipment)



11-seat configuration:

- one row of 4 seats (front)
- one row of 3 seats (middle)
- one row of 4 seats (rear)

12-seat configuration:

- one row of 4 seats (front)
- one row of 4 seats (middle)
- one row of 4 seats (rear)

Note: all the configurations can be fitted with 4-point harnesses (to be ordered separately).

The data set forth in this document are general in nature and for information purposes only.

For performance data and operating limitations, reference must be made to the approved flight manual and all appropriate documents.

Dimensions of compartments and accesses

Cabin main dimensions

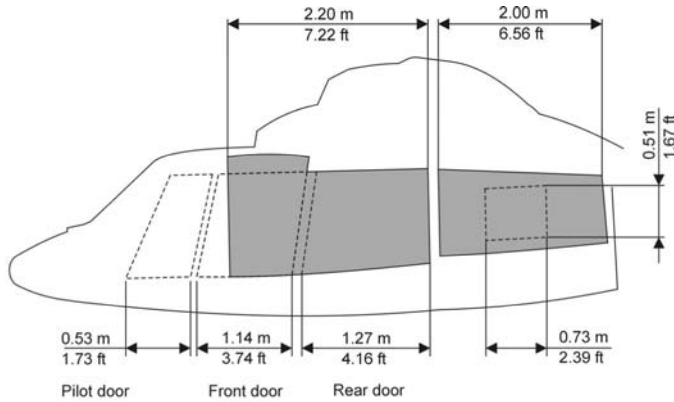

CABIN	
Area	4.20 m ² 45.20 sq.ft
Volume	5.10 m ³ 180.10 cu.ft

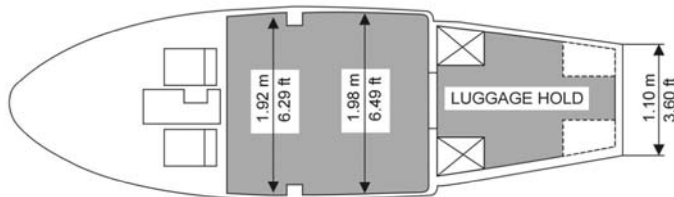

LUGGAGE HOLD	
Area	2.25 m ² 24.21 sq.ft
Volume	1.10 m ³ 38.84 cu.ft

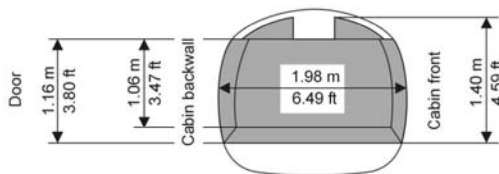

Cabin floor

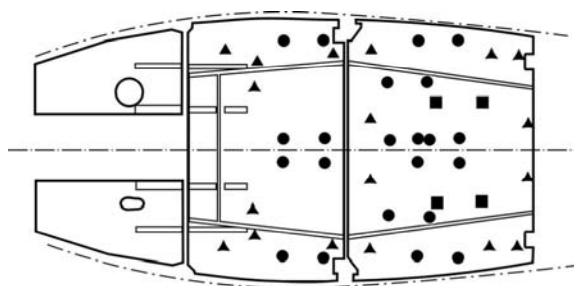

- Seat Anchoring Inserts
- ▲ Tie Down Rings
- Ferrying Tank Anchoring Inserts

The data set forth in this document are general in nature and for information purposes only.

For performance data and operating limitations, reference must be made to the approved flight manual and all appropriate documents.

Increased performance Power Plant...

Note: Thermal power, ISA, Sea Level

	kW	ch	shp
■ O.E.I. 30 seconds rating	729	990	977
■ OE.I. 2 minutes rating	656	891	879
■ Continuous O.E.I. rating	635	863	851
■ Take-Off Power	635	863	851
■ Maximum Continuous Power	597	811	800

... **with** modular design, for easier maintenance,
blade shedding and FADEC, for increased safety

- 1 axial compressor (1)
- 1 one-stage centrifugal compressor (2)
- 1 through-flow annular combustion (3) chamber with centrifugal fuel injection system
- 1 single-stage monocristal blade (4) generator turbine
- 1 rear bearing (5)
- 1 single-stage free turbine (6)
- 1 outlet diffuser (7)
- 1 reduction gearbox (8)
- 1 shielding rings for the turbines (9)
- 1 coupling shaft (10)
- 1 accessory gearbox (11)

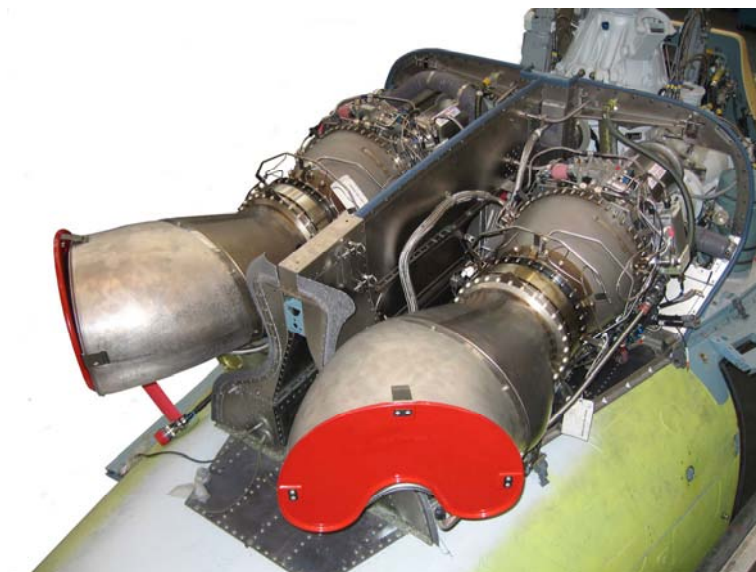
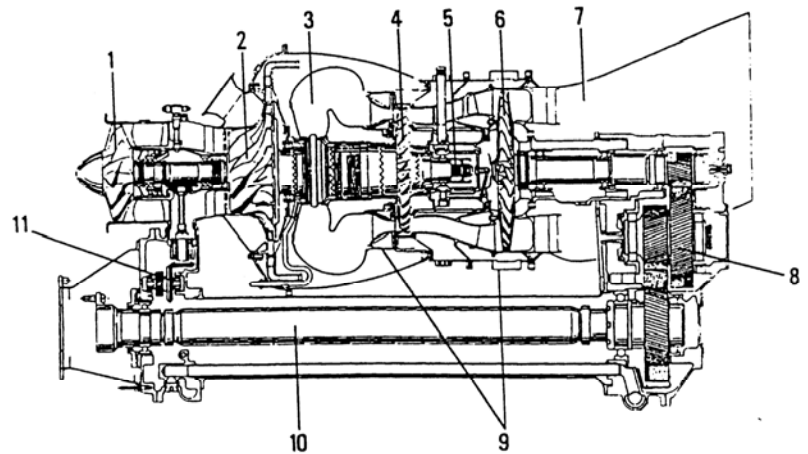

The data set forth in this document are general in nature and for information purposes only.

For performance data and operating limitations, reference must be made to the approved flight manual and all appropriate documents.

STARFLEX Main Rotor: reliability and simplicity



With a diameter of 11.94 m (39.17 ft), the main rotor includes a STARFLEX type rotor head and four fibreglass blades rotating clockwise (as viewed from above) at a nominal speed of 349.7 r.p.m. for an engine output speed of 5,990.4 r.p.m. This speed varies between 347 and 365 r.p.m. in flight (except in autorotation flight).



The STARFLEX rotor head combines simplicity and reliability:

- very few parts among which the main elements are fibreglass / carbon fiber composite (fail safe design)
- no bearing
- no lubrication

Main Rotor Blades:

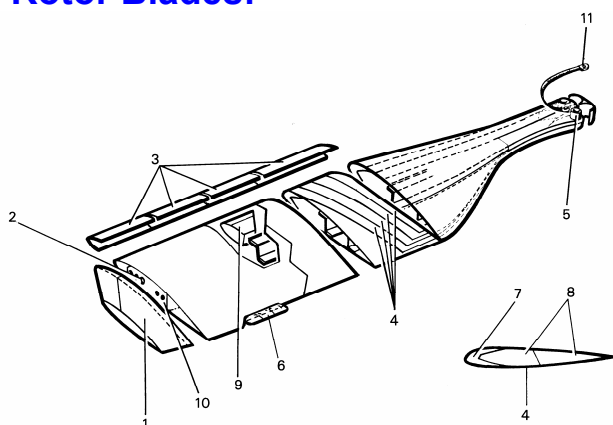

- | | |
|------------------------------|------------------------------|
| 1 - Blade tip cap | 7 - Fibreglass-rovng spar |
| 2 - Balancing weights | 8 - Moltoprene filler |
| 3 - Stainless steel strip | 9 - Integrated weight |
| 4 - Glass carbon fibre cloth | 10- Balancing weight support |
| 5 - Bushings | 11- Bonding strip |
| 6 - Tab | |

The main rotor blades take benefit of 30 years experience in composite material blades.

Immune to scratches and notches, corrosion free and impact resistant they are individually interchangeable and manually foldable.

The data set forth in this document are general in nature and for information purposes only.

For performance data and operating limitations, reference must be made to the approved flight manual and all appropriate documents.

FENESTRON Tail Rotor: safety and discretion

The *FENESTRON* tail rotor provides outstanding characteristics compared to classical tail rotors:

- safety on ground: with nearly 30 years in operation, no injury to ground personnel was reported;
- discretion: the 10 blades are unevenly distributed around the rotor hub to reduce noise
- safety in flight: tail fin asymmetrical profile design provides anti-torque thrust.



Tail Rotor Blades:

The 10 rotor carbon fibre composite blades take advantage from Resin Transfer Molding advanced technology.

Individually-interchangeable, they have the following characteristics:

- Length 0.505 m (1.656 ft)
- Chord length 0.094 m (0.308 ft)
- Profile O.A.F.
- Built-in twist - 10°



The data set forth in this document are general in nature and for information purposes only.

For performance data and operating limitations, reference must be made to the approved flight manual and all appropriate documents.

Instruments:



(*) optional equipment, to be ordered separately

Note: depending on the optional equipment to be installed the instrument panel here above may be organized differently.

Instrument-panel equipment:

- 2 Collins MFD-255 Primary Flight Displays (PFD)
- 2 Collins MFD-255 Navigation Displays (ND)
- 1 stand-by gyro-horizon
- 1 stand-by altimeter
- 1 stand-by airspeed indicator
- 1 dual torquemeter
- 2 engine T4 indicators
- 2 engine oil temperature indicators
- 2 engine oil pressure indicators
- 2 fuel pressure indicators
- 2 hydraulic circuit 1 and 2 pressure indicators
- 1 MGB oil pressure indicator
- 1 MGB oil temperature indicator
- 1 voltmeter
- 1 ammeter
- 1 dual fuel gauge
- 2 stopwatches
- 1 triple tachometer (rotor and engine 1 and 2 free wheel r.p.m)
- 1 rotor r.p.m tachometer
- 2 engine 1 and 2 Δ Ng indicators
- 1 electric and hydraulic power generation control panel
- 1 landing gear monitoring and control panel
- 1 warning panel
- 3 autopilot galvanometers
- 2 master alarm warning lights
- 2 manoeuvring limit (or torque limit, or gas generator r.p.m deviation limit) warning lights
- 1 "landing gear not extended" warning light
- 1 stand-by magnetic compass
- 1 outside air temperature indicator

Console equipment:

- 1 AFCS SFIM AP 155 control box
- 1 fuel circuit control and monitoring panel
- 1 gyro-magnetic compass control box
- 1 landing gear brake control handle
- 1 breaker panel

Main overhead panel standard equipment:

- 1 engine control panel with 2 fire warning lights and 2 dual fire extinguisher controls for engine bays
- lighting controls
- ventilation / heating system controls

The data set forth in this document are general in nature and for information purposes only.

For performance data and operating limitations, reference must be made to the approved flight manual and all appropriate documents.

3 - AS365 N3 - Standard Aircraft Definition

GENERAL

- Fuselage comprising the cabin and luggage hold.
- Luggage hold with floor, tie-down net and access door (RH).
- Tail boom with stabilizer fitted with 2 lateral fins and terminated by a shrouded tail rotor built into the vertical main fin.
- Retractable tricycle landing gear with axially lockable castoring nose wheel unit, assisted differential brakes on pilot's and copilot's stations and parking brake.
- 2 heated pitot heads
- Built-in foot-steps (2 on each side) for access to transmission deck.
- Anti-corrosion protection
- Fixed parts for the main blade-folding system.
- Structural reinforcements for 1,600 kg (3,527 lb) cargo-sling.
- Structural reinforcements for hoist.
- Jacking, hoisting, mooring and gripping points.
- Interior colour: beige.
- Exterior colour:
 - the fuselage is painted following per standard colour chart (scheme and colours, gloss or matt polyurethane finish), unless modified by option,
 - the landing gears are light blue,
 - the transmission deck (MGB & tail rotor drive shaft) are white,
 - the main rotor and tail rotor are grey,
 - the main rotor blades are kaki and the tail rotor blades are black.

CABIN

- 1 cabin floor capable of the various optional types of arrangements.
- 2 removable pilot and copilot high back-rest seats, adjustable in reach and height, each fitted with a safety belt and shoulder 4-point harness
- 8 standard seats fitted with cushions, 3-point harnesses.
- 2 pilot and copilot jettisonable doors, each fitted with a bad weather window and an internal storage unit.
- 2 hinged jettisonable cabin front doors
- 2 enlarged and bubbled rear sliding-doors with jettisonable window from inside and outside.
- 4 retractable foot-steps (2 on each side)
- Cabin upholstery with soundproofing
- 1 instrument panel, one console and one ceiling panel
- Dual flight controls
- Engine controls
- Rotor brake control
- 1 heating/demisting/ventilation system
- 2 upper tinted panes
- 2 front glass panes
- 2 windshield wipers
- 2 illuminated chart holders
- ⇒ 2 headset holders
- 1 portable fire-extinguisher
- 1 flight manual

INSTRUMENTS

- ⇒ 2 x 2 PFD/ND Collins MFD-255
- 1 stand-by gyro-horizon
- 1 stand-by altimeter
- 1 stand-by airspeed indicator
- 1 dual torquemeter, on pilot's side
- 2 engines exhaust pipes temperature indicators
- 2 engine oil pressure and temperature indicators
- 2 fuel pressure indicators
- 1 main gearbox oil pressure and temperature indicator
- 2 hydraulic pressure gauges
- 1 voltmeter
- 1 ammeter
- 1 dual fuel contents gauge
- 1 fuel circuit control and inspection panel
- 1 electrical control panel
- 1 AFCS control panel
- 1 landing gear position selector and indicator
- 2 stop watches
- 1 triple tachometer for rotor and engines 1 and 2 free turbine r.p.m., on pilot's side
- 1 rotor tachometer on copilot's side
- 2 ΔNG indicators (gas generators 1 and 2) with OEI rating operating lights
- 1 stand-by magnetic compass
- 1 outside air temperature indicator
- 1 warning panel
- 2 master alarm lights
- 2 manoeuvre limit warning lights
- 1 overhead panel including engine control panel with 2 fire warning lights and 2 dual fire extinguishing controls for engine bays
- 1 "L/G not extended" warning light
- Spare space for radar screen and radio com/nav. equipment

POWER PLANT

- 2 TURBOMECA ARRIEL 2C turbine engines providing each 729 kW (990 ch – 977 shp) super contingency rating, Full Authority Digital Engine Control system
The Digital Engine Control Unit (FADEC) provides the following main functions: variable rotor speed governing, training mode, automatic starting sequence.
Each engine is equipped with an anti-icing fuel system (efficient down to O.A.T. = -20°C)
- 1 fuel system including 5 tanks split into 2 groups, with a total usable capacity of 1,135 litres (300 US gal), 4 immersed booster pumps, 1 transfer pump and an indication of low levels
- 2 engine lubrication and oil cooling systems
- ⇒ 1 fuzz burner system on engine lubrication system
- 2 fire detection and extinguishing systems
- 2 anti-icing air-intake grids
- 2 phase angle torquemeter sensors built into the engines
- 2 engines exhaust pipes
- Engine flushing device (without cowlings removing)

The data set forth in this document are general in nature and for information purposes only.

For performance data and operating limitations, reference must be made to the approved flight manual and all appropriate documents.

TRANSMISSION SYSTEM

- 1 main gearbox, anti-vibration mounted, with oil sight, magnetic plug, oil pressure and temperature probe, lubrication circuit, thermal-switch, 2 rotor tachometer magnetic sensors and holes for endoscope and oil sampling
- 1 tail gearbox with oil sight and magnetic plug
- 1 main gearbox oil cooling system
- 2 engine/main gearbox coupling shafts
- 1 tail rotor drive shaft
- 1 rotor brake
- 2 free wheels integral with main gearbox

ROTORS AND FLIGHT CONTROLS

- 1 main rotor with 4 glass and carbon-fibre blades with STARFLEX® head fitted with gust and droop stops, mast fitted with rotor r.p.m. phonic-wheel
- 1 FENESTRON® type tail rotor with composite material blades built into the vertical fin
- 1 flight control system, fitted with 3 dual-chamber/dual-body main servo-units (on cyclic and collective pitch channels) and 1 dual-chamber/dual-body rear servo-unit (on tail rotor pitch control channel)
- 1 SFIM PA 155 D Duplex-type auto-pilot

ELECTRICAL INSTALLATION

- 2 static inverters (800 VA, 115/26 V, 400 Hz, 1-phase)
- 2 starter-generators (4.8 kW, 28 V D.C.)
- one 43 amp.-hr cadmium-nickel battery with temperature detector
- 1 external D.C. power receptacle
- 1 instrument white/blue lighting system
- 2 cabin extension lights
- 1 instrument light for flight in stormy conditions
- 1 cabin dome-light
- 4 cabin light strips
- 1 luggage hold dome-light
- 3 position lights
- 1 anti-collision light
- Retractable LH landing light, adjustable in elevation
- ⇒ Retractable RH landing light, adjustable in elevation and in azimuth allowing search-light and hoist light
- 1 cabin power outlet (28 V.D.C.)
- 1 emergency battery for automatic lighting of the dome-lights and signs

HYDRAULIC GENERATION

- 2 independent hydraulic systems feeding the servo-units, landing gear actuation system and assisted brakes
- Self-sealing hydraulic ground coupling
- 1 stand-by hydraulic system with electro-pump for emergency actuating of the landing gear, hydraulic assistance for flight controls tests on ground with rotor stopped and park brake pressure.

AIRBORNE KIT (*)

- 2 pitot head covers
- 2 static vent blanks
- 2 engine air-intake blanks
- 2 engines exhaust pipe blanks
- 7 mooring rings
- 2 rough weather tie-down rings
- 2 gripping rings
- 1 main blade tie-down kit
- 1 set of jacking pads
- 1 fuel tanks bleed tool
- 1 data case
- 1 airborne kit stowing bag

(*) weight not included in standard aircraft empty weight.

⇒ Main improvements of the year 2006

The data set forth in this document are general in nature and for information purposes only.

For performance data and operating limitations, reference must be made to the approved flight manual and all appropriate documents.

4 - Optional equipment

Symbol  shown beside an item denotes some constraint (see table on page 21)

Note: weight breakdown values are given for information and shall not be considered as contractual.

Document reference	Commercial reference	Name	kg	lb
		1/ STANDARD AIRCRAFT		
		AS365 N3 06.100.01 E	2,389.0	5,267.0
00-50021-A	05-50021-00-CI	2/ AS365 N3 MINIMUM EQUIPMENT PACKAGE ¹	72.4	159.6
		VHF-AM Honeywell KTR 908 (No.1)		
		VHF-AM Honeywell KTR 908 (No.2)		
		Inter Communication System Team TB 31 with 2 control boxes 1976		
		Passengers address with 4 loudspeakers NAT AA 20-431		
		Crew headsets Silec 4449-1 (Qty 2)		
		Radio altimeter Thales AHV 16 (displayed on MFD-255)		
		Transponder Honeywell MST-67A with flight ident function (including S mode) ²		
		ADF Honeywell KDF 806 (displayed on MFD-255)		
		DME Honeywell KDM 706 A (displayed on MFD-255)		
		VOR/ILS/MKR - Honeywell - KNR 634A n°1 displayed on MFD-255		
		VOR/ILS/MKR - Honeywell - KNR 634A n°2 displayed on MFD-255		
		GPS navigation system ³ Freeflight 2101 I/O Approach+		
		Air Data Computer Shadin ADC 2000		
		Flight Director Coupler (3-axis) Sfim CDV 85 D3		

¹ In addition to this package a beacon must be selected in the possible optional equipment (ELT or/and ADELTA).

² The mode S identification must be communicated by the customer two months at the latest before the delivery.

³ The customer must take out a subscription to the data base in order to use the GPS after having taken delivery of the helicopter.

The data set forth in this document are general in nature and for information purposes only.

For performance data and operating limitations, reference must be made to the approved flight manual and all appropriate documents.

Document reference	Commercial reference	Name	kg	lb	
3/ POSSIBLE OPTIONAL EQUIPMENT					
General equipment					
	05-01004-A	05-01004-00-CI	FAA certification kit	0	0
⚠	05-02011-A	05-02011-00-CI	Customized external paint (level 1)	1.5	3.3
⚠	05-02037-A	05-02037-00-CI	Customized external paint (level 2)	1.5	3.3
	05-03010-A	05-03010-00-CI	First aid kit – JAR OPS 3 compatible	5.0	11.0
	05-21008-A	05-21008-00-CI	Wire strike protection system (upper cutter)	7.5	16.5
⚠	05-24006-A	05-24006-00-CI	High visibility markings of main rotor blades	0.3	0.7
⚠	05-24007-A	05-24007-00-CI	High visibility markings of main rotor blades tip cap	0.15	0.3
	05-25009-A	05-25009-00-FP	Sand prevention filters, dynamic type - Fixed Parts ¹	2.8	6.2
⚠		05-25009-00-RP	Sand prevention filters, dynamic type - Removable Parts ¹	11.0	24.3
	05-25011-A	05-25011-00-CI	Re-inforced sand erosion protection strip on main rotor blades	0.4	0.9
	05-25020-A	05-25020-00-CI	Re-inforced sand erosion protection strip on tail rotor blades	0.1	0.2
	05-27005-A	05-27005-00-CI	Second fire extinguisher in cabin	2.4	5.3
⚠	05-31008-A	05-31008-00-CI	Sliding window on the rear enlarged bubble sliding door - Right hand side	1.0	2.2
⚠	05-31009-A	05-31009-00-CI	Sliding window on the rear enlarged bubble sliding door - Left hand side	1.0	2.2
	05-31038-A	05-31038-00-CI	Green tinted plexiglass panes (cabin only)	0	0
	05-32009-A	05-32009-00-CI	Windshield washer	2.3	5.1
⚠	05-42023-A	05-42023-00-CI	Air conditioning system (compact)	56.0	123.5
⚠	05-42026-A	05-42026-00-CI	Air conditioning system (split)	45.4	100.1
⚠	05-51004-A	05-51004-00-CI	Heated windshield	1.3	2.9
	05-52009-A	05-52009-00-CI	Icing detector (Rosemount)	1.1	2.4
	05-62013-A	05-62013-00-CI	10-kVA A.C. alternator	27.8	61.3
	05-81018-A	05-81018-00-FP	Auxiliary fuel tank in the hold (180 litres - 47 US gal.) - Fixed Parts	3.9	8.6
⚠		05-81018-00-RP	Auxiliary fuel tank in the hold (180 litres - 47 US gal.) - Removable Parts	23.7	52.2
⚠	05-82021-A	05-82021-00-FP	Fuel jettison system - Fixed Parts	1.9	4.2
⚠		05-82021-00-RP	Fuel jettison system - Removable Parts	4.7	10.4
⚠	05-84003-A	05-84003-00-CI	Ferrying tank (460 litres - 121 US gal.)	5.3	11.7
⚠	05-85006-A	05-85006-00-CI	Fuel flowmeter displayed on Faure Herman Indicator	3.2	7.1
⚠	05-85009-A	05-85009-00-CI	Fuel flowmeter displayed on GPS Freeflight 2101 I/O Approach+ ²	2.5	5.5
	05-92003-A	05-92003-00-RP	Blade folding kit - Removable Parts ³	30.0	66.1

¹ Includes the supply of the standard cowlings.

² Requires the "GPS Freeflight 2101 I/O Approach +".

³ Fixed Parts are included in the Standard AS365 N3.

The data set forth in this document are general in nature and for information purposes only.

For performance data and operating limitations, reference must be made to the approved flight manual and all appropriate documents.













Document reference	Commercial reference	Name	kg	lb
Specific mission equipment				
	06-11027-A	06-11027-00-FP Anti-sticking protection - Fixed Parts	9.1	20.1
		06-11027-00-RP Anti-sticking protection - Removable Parts	22.0	48.5
⚠	06-21010-A	06-21010-00-FP BFGoodrich Class 2 electrical hoist (272 kg - 90 m) - Fixed Parts	3.6	7.9
⚠		06-21010-00-RP BFGoodrich Class 2 electrical hoist (272 kg - 90 m) - Removable Parts	68.1	150.1
⚠	06-21022-A	06-21022-00-FP BFGoodrich Class 1 electrical hoist (272 kg - 90 m) - Fixed Parts	4.0	8.8
⚠		06-21022-00-RP BFGoodrich Class 1 electrical hoist (272 kg - 90 m) - Removable Parts	73.1	161.2
⚠	06-24002-A	06-24002-00-FP Rappelling (ropes are not included) - Fixed Parts	3.3	7.3
⚠		06-24002-00-RP Rappelling (ropes are not included) - Removable Parts	2.6	5.7
	06-27010-A	06-27010-00-FP Cargo sling with dynamometer and outside mirrors (1,600 kg - 3,527 lb) - Fixed Parts	8.6	19.0
⚠		06-27010-00-RP Cargo sling with dynamometer and outside mirrors (1,600 kg - 3,527 lb) - Removable Parts	19.0	41.9
	06-31009-A	06-31009-00-FP Electrical hailer with siren system - Fixed Parts	7.0	15.4
⚠		06-31009-00-RP Electrical hailer with siren system - Removable Parts	11.0	24.3
	06-41002-A	06-41002-00-CI Under fuselage anti-collision strobe light	1.5	3.3
	06-41009-A	06-41009-00-CI Tail fin anti-collision strobe light	0.2	0.4
⚠	06-45009-A	06-45009-00-FP Spectrolab SX-16 searchlight - Fixed Parts	4.8	10.6
⚠		06-45009-00-RP Spectrolab SX-16 searchlight - Removable Parts	31.5	69.5
⚠	06-45029-A	06-45029-00-CI Infrared filter for Spectrolab SX-16 searchlight ¹	1.5	3.3
⚠	06-45034-A	06-45034-00-FP Spectrolab SX-5 searchlight - Fixed Parts	4.8	10.6
⚠	06-45034-A	06-45034-00-RP Spectrolab SX-5 searchlight - Removable Parts	25.0	55.1
⚠	06-45037-A	06-45037-00-CI Infrared filter for Spectrolab SX-5 searchlight ¹	1.0	2.2
⚠	06-45038-A	06-45038-00-FP Spectrolab SX-16 searchlight with infrared in-flight changeover - Fixed Parts	4.8	10.6
⚠		06-45038-00-RP Spectrolab SX-16 searchlight with infrared in-flight changeover - Removable Parts ¹	41.9	92.4
	06-61020-A	06-61020-00-FP Emergency floatation gear with automatic percussion - Fixed Parts	14.5	32.0
⚠		06-61020-00-RP Emergency floatation gear with automatic percussion - Removable Parts	44.3	97.7
⚠	06-62002-A	06-62002-00-FP Aerazur life-raft installation - Fixed Parts ²	-1.7	-3.7
⚠		06-62002-00-RP Aerazur life-raft installation - Removable Parts ²	63.6	140.2
⚠	06-66012-A	06-66012-00-CI Helicopter Emergency Egress Lighting (HEEL)	4.0	8.8

¹ NVG compatibility.

² Deliverable with standard upholstery.

The data set forth in this document are general in nature and for information purposes only.

For performance data and operating limitations, reference must be made to the approved flight manual and all appropriate documents.

Document reference	Commercial reference	Name	kg	lb
Specific mission equipment (continued)				
 06-67012-A	06-67012-00-CI	Emergency Locator Transmitter Kannad 406-AF ¹	2.4	5.3
 06-67012-A	06-67012-02-CI	Emergency Locator Transmitter Kannad 406-AF with GPS connection ¹	3.1	6.8
06-67041-A	06-67041-00-CI	HR Smith series 503 ADELTA ¹	7.1	15.7
06-68003-A	06-68003-00-CI	Under Water Acoustic Beacon Dukane DK 100	0.5	1.1
06-69004-A	06-69004-00-CI	Automatic Voice Alarm Device RACAL V 694	2.3	5.1
06-70003-A	06-70003-00-CI	Kit for flight with night vision goggles (goggles not included) ²⁻³	5	11.0
 06-81008-A	06-81008-00-FP	Fire-fighting "BAMBI BUCKET" (910 litres) - Fixed Parts	4.0	7.1
 06-81008-A	06-81008-00-RP	Fire-fighting "BAMBI BUCKET" (910 litres)- Removable Parts	61.0	113.8
Interior layout				
07-15001-A	07-15001-00-CI	Pilot and copilot "energy absorber" seats	16.0	35.3
 07-25002-A	07-25002-00-CI	12 seat lay-out complement	16.0	35.3
 07-25009-A	07-25009-00-CI	11 seat lay-out complement	11.0	24.2
 07-25011-A	07-25011-00-CI	8 seat "Executive" installation with sound-proofing and carpeting	63.0	138.9
07-25033-A	07-25033-00-CI	4 points harnesses for 8 standard seat lay-out	3.1	6.8
 07-25034-A	07-25034-00-CI	4 points harnesses for 11 standard seat lay-out complement	2.7	6.0
 07-25050-A	07-25050-00-CI	4 points harnesses for 12 seat lay-out complement	2.7	6.0
 07-30003-A	07-30003-00-CI	Comfort upholstery with improved sound-proofing and carpeting	57.0	125.7
 07-50010-A	07-50010-00-CI	2 hinged passengers doors with 2 rear doors extensions (instead of the standard sliding doors)	12.0	26.5
 07-71015-A	07-71015-00-FP	Casualty-carrying installation for 4 stretchers (excluding stretchers) - Fixed Parts ⁴	1.8	4.0
 07-71015-A	07-71015-00-RP	Casualty-carrying installation for 4 stretchers (excluding stretchers) - Removable Parts ⁴	9.5	20.9

¹ The Programming Data Sheet must be filled and communicated by the customer two months at the latest before the helicopter's delivery.

² This equipment is submitted to Export Licence Allowance.

³ The references of most equipment fitted with a control box must be changed to switch to NVG compatible version.

⁴ The corresponding stretchers are not certified.

The data set forth in this document are general in nature and for information purposes only.

For performance data and operating limitations, reference must be made to the approved flight manual and all appropriate documents.

Document reference	Commercial reference	Name	kg	lb
Interior layout (continued)				
⚠ 07-74004-A	07-74004-00-CI	Stretchers for "Casualty-carrying installation for 4 stretchers" (Qty 4) ¹	9.3	20.5
⚠ 07-81001-A	07-81001-00-CI	5-seat VIP installation	237.0	522.5
⚠ 07-81002-A	07-81002-00-CI	6-seat VIP installation (2+4)	240.0	529.1
⚠ 07-81003-A	07-81003-00-CI	7-seat VIP installation	250.0	551.1
⚠ 07-81019-A	07-81019-00-CI	6-seat VIP installation (3+3)		
⚠ 07-82005-A	07-82005-00-CI	Headrests (Qty 8) ² & floor inserts for 8-seat face-to-face installation	4.0	8.8
Avionics				
	08-10001-A	08-10001-00-CI HF/SSB Collins HF 9100	23.0	50.7
	08-12011-A	08-12011-00-CI VHF/FM Maritime NAT NPX 138	2.5	5.5
	08-14010-A	08-14010-00-CI VHF/UHF Allied Signal RT 5000	14.0	30.9
	08-16015-A	08-16015-00-CI Third control box 1976 in cabin for Team TB 31 ICS	3.0	6.6
⚠	08-16019-A	08-16019-00-CI Fourth control box 1976 for Team TB 31 ICS	3.0	6.6
	08-17015-A	08-17015-00-CI Passenger interphone (for 8 passengers)Team BA 1920	1.3	2.9
⚠	08-17015-A	08-17015-01-CI Passenger interphone Team BA 1920 (for VIP installation)	1.6	3.5
	08-17016-A	08-17016-00-CI Passenger interphone for active noise cancelling headsets 1 x NAT AA-36 + 2 x NAT AA-82	1.8	4.0
	08-18022-A	08-18022-00-CI Elno FPH 600 helmet ³	1.1	2.4
	08-18027-A	08-18027-00-CI Crew headset Silec 4449-1 ³	0.5	1.1
	08-18031-A	08-18031-00-CI Crew headset David Clark H 10-66 ³	0.5	1.1
⚠	08-18029-A	08-18029-00-CI Active noise cancelling headset BOSE X ³	0.5	1.1
	08-22033-A	08-22033-00-CI R4 AIS transponder (under study)	2.5	5.5
	08-22037-A	08-22037-00-CI Transponder Collins TDR 94 D-007 with flight ident function	6.0	13.2
	08-27035-A	08-27035-00-CI SAR Homer Chelton System 7 (displayed on MFD-255)	4.5	9.9
⚠	08-31036-A	08-31036-00-CI Telephonics RDR-1400C weather/search radar (displayed on MFD-255)	18.2	40.1
⚠	08-31038-A	08-31038-00-CI Honeywell RDR 2000 weather radar (displayed on KMD-850 - not included)	9.6	21.2
	08-35016-A	08-35016-00-CI EGPWS Honeywell MK XXII with dedicated TRA45A indicator	9.0	19.8

¹ Not certified equipment.

² Mandatory for seats facing backwards.

³ Quantity to be defined.

The data set forth in this document are general in nature and for information purposes only.

For performance data and operating limitations, reference must be made to the approved flight manual and all appropriate documents.

Document reference	Commercial reference	Name	kg	lb
Avionics (continued)				
⚠ 08-35019-A	08-35019-00-CI	TCAS - Goodrich - Skywatch HP 899 (displayed on KMD850 - not included)	10.5	23.1
⚠ 08-38004-A	08-38004-00-CI	BFGoodrich WX1000E Stormscope (displayed on KMD850 - not included)	15.0	33.1
⚠ 08-46022-A	08-46022-00-CI	Moving map Euroavionics Euronav IV linked to GPS, and displayed on 10.4" MFD (MFD not included)	8.3	18.3
⚠ 08-46029-A	08-46029-00-CI	Honeywell KMD 850 Jeppesen map ¹	3.0	6.6
08-57001-A	08-57001-00-CI	Altitude encoder Shadin 8800 T	0.5	1.1
08-65010-A	08-65010-00-CI	Skyquest 10,4" display	2.6	5.7
08-81023-A	08-81023-00-CI	Solid State Cockpit Voice & Flight Data Recorder Honeywell AR COMBI (2 hours CVR and 10 hours FDR recording) ²⁻³	14	30.9
⚠ 08-83010-A	08-83010-00-CI	UMS - complement of SSCVFDR (usage functions)	1.5	3.3
⚠ 08-83012-A	08-83012-00-CI	HUMS - complement of UMS (health functions)	10.5	23.1
⚠ 08-83023-A	08-83023-00-CI	QAR (Quick Access Recorder) for HOMP	1.0	2.2
08-91006-A	08-91006-00-CI	Hourmeter	0.1	0.2
Customized & Vendor supplied equipment				
Vendor - Specific Mission Equipment				
	Aerazur	Separate life raft (6 persons) ⁴	17.3	38.1
	Transaco	Hoistable stretcher for land & sea operations	14.0	30.9
	Simplex	Fire fighting installation System (STC certification)	28.0	61.7
Vendor - E.M.S. Installations				
	A.A.T.	"Basic" EMS kit (1 stretcher) ⁵⁻⁶	37.4	82.5
	A.A.T.	"Rescue" EMS kit (1 stretcher with medical equipment carrier) ⁵⁻⁶	56.4	124.3
	A.A.T.	"Disaster" EMS kit (2 stretchers with medical equipment carrier) ⁵⁻⁶	96.5	212.7

¹ Includes Digital Jeppesen Map. The operational geographic zone of the helicopter must be communicated by the customer two months at the latest before the delivery.

² Includes an underwater beacon.

³ Includes ADC2000 Air Data Computer, instead of Altitude encoder Shadin 8800 T.

⁴ The vendor is responsible for the conformity, performance and certification of this installation regarding the final customer.

⁵ "Air Ambulance Technology" (A.A.T.) is in charge of the fitting of the ambulance installation on the aircraft. Any request from a customer should be subject of a specific quotation from A.A.T.

⁶ A.A.T is responsible for the conformity, performance and certification of this installation regarding the final customer.

The data set forth in this document are general in nature and for information purposes only.

For performance data and operating limitations, reference must be made to the approved flight manual and all appropriate documents.

Blank

The data set forth in this document are general in nature and for information purposes only.

For performance data and operating limitations, reference must be made to the approved flight manual and all appropriate documents.

5- Table of Constraints

EXL Impossibility of simultaneous fitment of the fixed parts of 2 items of equipment

NSF Total or partial incompatibility of simultaneous fitment of the removal parts of two items of equipment

NSU Possibility of simultaneous fitment on the same aircraft, but impossible to use simultaneously

REQ Requires the fitting of

Document Reference	Commercial Reference	Installation	Nature of the Constraint				Commercial Reference	Installation	Document Reference
			EXL	NSF	NSU	REQ			
05-02011-A	05-02011-00-CI	Customized external paint (level 1)	X				05-02037-00-CI	Customized external paint (level 2)	05-02037-A
05-02037-A	05-02037-00-CI	Customized external paint (level 2)	X				05-02011-00-CI	Customized external paint (level 1)	05-02011-A
05-24006-A	05-24006-00-CI	High visibility markings of main rotor blades	X				05-24007-00-C	High visibility markings of main rotor blades tip cap	05-24007-A
05-24007-A	05-24007-00-CI	High visibility markings of main rotor blades tip cap	X				05-24006-00-CI	High visibility markings of main rotor blades	05-24006-A
05-25009-A	05-25009-00-RP	Sand prevention filters, dynamic type - Removable Parts				X	05-25009-00-FP	Sand prevention filters, dynamic type - Fixed Parts	05-25009-A
05-31008-A	05-31008-00-CI	Sliding window on the rear enlarged bubble sliding door - Right Hand side	X				07-50010-00-CI	2 hinged passengers doors with 2 rear doors extensions (instead of the standard sliding doors)	07-50010-A
05-31009-A	05-31009-00-CI	Sliding window on the rear enlarged bubble sliding door - Left Hand side	X				07-50010-00-CI	2 hinged passengers doors with 2 rear doors extensions (instead of the standard sliding doors)	07-50010-A
05-42023-A	05-42023-00-CI	Air conditioning system (compact)	X				05-42026-00-CI	Air conditioning system (split)	05-42026-A
					X		06-21010-00-RP	BFGoodrich Class 2 electrical hoist (272 kg - 90 m) - Removable Parts	06-21010-A
					X		06-21022-00-RP	BFGoodrich Class 1 electrical hoist (272 kg - 90 m) - Removable Parts	06-21022-A
05-42026-A	05-42026-00-CI	Air conditioning system (split)	X				05-42023-00-CI	Air conditioning system (compact)	05-42023-A
			X				06-62002-00-FP	Aerazur life-raft installation - Fixed Parts	06-62002-A
					X		06-21010-00-RP	BFGoodrich Class 2 electrical hoist (272 kg - 90 m) - Removable Parts	06-21010-A
					X		06-21022-00-RP	BFGoodrich Class 1 electrical hoist (272 kg - 90 m) - Removable Parts	06-21022-A
05-51004-A	05-51004-00-CI	Heated windshield				X	05-62013-00-CI	10-kVA A.C. alternator	05-62013-A
05-81018-A	05-81018-00-RP	Auxiliary fuel tank in the hold (180 litres - 47 US gal.) - Removable Parts				X	05-81018-00-FP	Auxiliary fuel tank in the hold (180 litres - 47 US gal.) - Fixed Parts	05-81018-A
05-82021-A	05-82021-00-FP	Fuel jettison system – Fixed Parts	X				06-81008-00-FP	Fire-fighting "BAMBI BUCKET" (910 litres) - Fixed Parts	06-81008-A
	05-82021-00-RP	Fuel jettison system – Removable Parts	X				06-81008-00-FP	Fire-fighting "BAMBI BUCKET" (910 litres) - Fixed Parts	06-81008-A
						X	05-82021-00-FP	Fuel jettison system – Fixed Parts	05-82021-A

The data set forth in this document are general in nature and for information purposes only.

For performance data and operating limitations, reference must be made to the approved flight manual and all appropriate documents.

Document Reference	Commercial Reference	Installation	Nature of the Constraint				Commercial Reference	Installation	Document Reference
			EXL	NSF	NSU	REQ			
05-84003-A	05-84003-00-CI	Ferrying tank (460 litres - 121 US gal.)		X			07-25002-00-CI	12 seat lay-out complement	07-25002-A
				X			07-25009-00-CI	11 seat lay-out complement	07-25009-A
				X			07-25011-00-CI	8-seat "Executive" installation with sound-proofing and carpeting	07-25011-A
				X			07-30003-00-CI	Comfort upholstery with improved sound-proofing and carpeting	07-30003-A
				X			07-71015-00-RP	Casualty-carrying installation for 4 stretchers (excluding stretchers) - Removable Parts	07-71015-A
				X			07-74004-00-CI	Stretchers for "Casualty-carrying installation for 4 stretchers" (Qty 4)	07-74004-A
				X			06-24002-00-RP	Rappelling (ropes are not included) - Removable Parts	06-24002-A
05-85006-A	05-85006-00-CI	Fuel flowmeter displayed on FAURE HERMAN Indicator	X			05-85009-00-CI	Fuel flowmeter displayed on GPS Freeflight 2101 I/O Approach +	05-85009-A	
05-85009-A	05-85009-00-CI	Fuel flowmeter displayed on GPS Freeflight 2101 I/O Approach +	X			05-85006-00-CI	Fuel flowmeter displayed on FAURE HERMAN Indicator	05-85006-A	
06-21010-A	06-21010-00-FP	BFGoodrich Class 2 electrical hoist (272 kg - 90 m) - Fixed Parts	X				06-21022-00-FP	BFGoodrich Class 1 electrical hoist (272 kg - 90 m) - Fixed Parts	06-21022-A
			X				07-50010-00-CI	2 hinged passengers doors with 2 rear doors extensions (instead of the standard sliding doors)	07-50010-A
			X				07-81001-00-CI	5-seat VIP installation	07-81001-A
			X				07-81002-00-CI	6-seat VIP installation (2+4)	07-81002-A
			X				07-81003-00-CI	7-seat VIP installation	07-81003-A
			X				07-81019-00-CI	6-seat VIP installation (3+3)	07-81019-A
					X		08-16015-00-CI	Third control box 1976 in cabin for TEAM TB 31 ICS	08-16015-A
					X		06-21022-00-FP	BFGoodrich Class 1 electrical hoist (272 kg - 90 m) - Fixed Parts	06-21022-A
	06-21010-00-RP	BFGoodrich Class 2 electrical hoist (272 kg - 90 m) - Removable Parts	X				07-50010-00-CI	2 hinged passengers doors with 2 rear doors extensions (instead of the standard sliding doors)	07-50010-A
			X				07-81001-00-CI	5-seat VIP installation	07-81001-A
			X				07-81002-00-CI	6-seat VIP installation (2+4)	07-81002-A
			X				07-81003-00-CI	7-seat VIP installation	07-81003-A
			X				07-81019-00-CI	6-seat VIP installation (3+3)	07-81019-A
					X		07-25011-00-CI	8-seat "Executive" installation with sound-proofing and carpeting	07-25011-A
					X		07-30003-00-CI	Comfort upholstery with improved sound-proofing and carpeting	07-30003-A
					X		07-71015-00-RP	Casualty-carrying installation for 4 stretchers (excluding stretchers) - Removable Parts	07-71015-A
					X		07-74004-00-CI	Stretchers for "Casualty-carrying installation for 4 stretchers" (Qty 4)	07-74004-A
			X	05-42023-00-CI	Air conditioning system (compact)	05-42023-A			
			X	05-42026-00-CI	Air conditioning system (split)	05-42026-A			
			X	06-24002-00-RP	Rappelling (ropes are not included) - Removable Parts	06-24002-A			

The data set forth in this document are general in nature and for information purposes only.

For performance data and operating limitations, reference must be made to the approved flight manual and all appropriate documents.

Document Reference	Commercial Reference	Installation	Nature of the Constraint				Commercial Reference	Installation	Document Reference
			EXL	NSF	NSU	REQ			
	06-21010-00-RP (continued)	BFGoodrich Class 2 electrical hoist (272 kg - 90 m) - Removable Parts (continued)			X		06-27010-00-RP	Cargo sling with dynamometer and outside mirrors (1,600 kg - 3,527 lb) - Removable Parts	06-27010-A
					X		06-81008-00-RP	Fire-fighting "BAMBI BUCKET" (910 litres) - Removable Parts	06-81008-A
					X		07-25002-00-CI	12 seat lay-out complement	07-25002-A
					X		07-25009-00-CI	11 seat lay-out complement	07-25009-A
					X		06-21010-00-FP	BFGoodrich Class 2 electrical hoist (272 kg - 90 m) - Fixed Parts	06-21010-A
					X		08-16015-00-CI	Third control box 1976 in cabin for TEAM TB 31 ICS	08-16015-A
06-21022-A	06-21022-00-FP	BFGoodrich Class 1 electrical hoist (272 kg - 90 m) - Fixed Parts	X				06-21010-00-FP	BFGoodrich Class 2 electrical hoist (272 kg - 90 m) - Fixed Parts	06-21010-A
			X				07-50010-00-CI	2 hinged passengers doors with 2 rear doors extensions (instead of the standard sliding doors)	07-50010-A
			X				07-81001-00-CI	5-seat VIP installation	07-81001-A
			X				07-81002-00-CI	6-seat VIP installation (2+4)	07-81002-A
			X				07-81003-00-CI	7-seat VIP installation	07-81003-A
			X				07-81019-00-CI	6-seat VIP installation (3+3)	07-81019-A
					X		08-16015-00-CI	Third control box 1976 in cabin for TEAM TB 31 ICS	08-16015-A
06-21022-A	06-21022-00-RP	BFGoodrich Class 1 electrical hoist (272 kg - 90 m) - Removable Parts	X				06-21010-00-FP	BFGoodrich Class 2 electrical hoist (272 kg - 90 m) - Fixed Parts	06-21010-A
			X				07-50010-00-CI	2 hinged passengers doors with 2 rear doors extensions (instead of the standard sliding doors)	07-50010-A
			X				07-81001-00-CI	5-seat VIP installation	07-81001-A
			X				07-81002-00-CI	6-seat VIP installation (2+4)	07-81002-A
			X				07-81003-00-CI	7-seat VIP installation	07-81003-A
			X				07-81019-00-CI	6-seat VIP installation (3+3)	07-81019-A
					X		07-25011-00-CI	8-seat "Executive" installation with sound-proofing and carpeting	07-25011-A
					X		07-30003-00-CI	Comfort upholstery with improved sound-proofing and carpeting	07-30003-A
					X		07-71015-00-RP	Casualty-carrying installation for 4 stretchers (excluding stretchers) - Removable Parts	07-71015-A
					X		07-74004-00-CI	Stretchers for "Casualty-carrying installation for 4 stretchers" (Qty 4)	07-74004-A
					X		05-42023-00-CI	Air conditioning system (compact)	05-42023-A
					X		05-42026-00-CI	Air conditioning system (split)	05-42026-A
					X		06-24002-00-RP	Rappelling (ropes are not included) - Removable Parts	06-24002-A
					X		06-27010-00-RP	Cargo sling with dynamometer and outside mirrors (1,600 kg - 3,527 lb) - Removable Parts	06-27010-A
					X		06-81008-00-RP	Fire-fighting "BAMBI BUCKET" (910 litres) - Removable Parts	06-81008-A
					X		07-25002-00-CI	12 seat lay-out complement	07-25002-A

The data set forth in this document are general in nature and for information purposes only.

For performance data and operating limitations, reference must be made to the approved flight manual and all appropriate documents.

Document Reference	Commercial Reference	Installation	Nature of the Constraint				Commercial Reference	Installation	Document Reference
			EXL	NSF	NSU	REQ			
	06-21022-00-RP (continued)	BFGoodrich Class 1 electrical hoist (272 kg - 90 m) - Removable Parts (continued)			X		07-25009-00-CI	11 seat lay-out complement	07-25009-A
					X		06-21022-00-FP	BFGoodrich Class 1 electrical hoist (272 kg - 90 m) - Fixed Parts	06-21022-A
					X		08-16015-00-CI	Third control box 1976 in cabin for TEAM TB 31 ICS	08-16015-A
06-24002-A	06-24002-00-FP	Rappelling (ropes are not included) – Fixed Parts	X				07-50010-00-CI	2 hinged passengers doors with 2 rear doors extensions (instead of the standard sliding doors)	07-50010-A
			X				07-81001-00-CI	5-seat VIP installation	07-81001-A
			X				07-81002-00-CI	6-seat VIP installation (2+4)	07-81002-A
			X				07-81003-00-CI	7-seat VIP installation	07-81003-A
			X				07-81019-00-CI	6-seat VIP installation (3+3)	07-81019-A
	06-24002-00-RP	Rappelling (ropes are not included) - Removable Parts	X				07-50010-00-CI	2 hinged passengers doors with 2 rear doors extensions (instead of the standard sliding doors)	07-50010-A
			X				07-81001-00-CI	5-seat VIP installation	07-81001-A
			X				07-81002-00-CI	6-seat VIP installation (2+4)	07-81002-A
			X				07-81003-00-CI	7-seat VIP installation	07-81003-A
			X				07-81019-00-CI	6-seat VIP installation (3+3)	07-81019-A
				X			07-71015-00-RP	Casualty-carrying installation for 4 stretchers (excluding stretchers) – Removable Parts	07-71015-A
				X			07-74004-00-CI	Stretchers for "Casualty-carrying installation for 4 stretchers" (Qty 4)	07-74004-A
					X		05-84003-00-CI	Ferrying tank (460 litres - 121 US gal.)	05-84003-A
					X		06-21010-00-RP	BFGoodrich Class 2 electrical hoist (272 kg - 90 m) - Removable Parts	06-21010-A
					X		06-21022-00-RP	BFGoodrich Class 1 electrical hoist (272 kg - 90 m) - Removable Parts	06-21022-A
					X		06-27010-00-RP	Cargo sling with dynamometer and outside mirrors (1,600 kg - 3,527 lb capacity) - Removable Parts	06-27010-A
					X		06-31009-00-RP	Electrical hailer with siren system – Removable Parts	06-31009-A
					X		06-45009-00-RP	Spectrolab SX-16 searchlight - Removable Parts	06-45009-A
					X		06-45034-00-RP	Spectrolab SX-5 searchlight – Removable Parts	06-45034-A
					X		06-45038-00-RP	Spectrolab SX-16 searchlight with infrared in-flight changeover - Removable Parts	06-45038-A
					X		06-81008-00-RP	Fire-fighting "BAMBI BUCKET" (910 litres) - Removable Parts	06-81008-A
					X		07-25002-00-CI	12 seat lay-out complement	07-25002-A
					X		07-25009-00-CI	11 seat lay-out complement	07-25009-A
					X		07-25011-00-CI	8-seat "Executive" installation with sound-proofing and carpeting	07-25011-A
					X		06-24002-00-FP	Rappelling (ropes are not included) – Fixed Parts	06-24002-A

The data set forth in this document are general in nature and for information purposes only.

For performance data and operating limitations, reference must be made to the approved flight manual and all appropriate documents.

Document Reference	Commercial Reference	Installation	Nature of the Constraint				Commercial Reference	Installation	Document Reference
			EXL	NSF	NSU	REQ			
06-27010-A	06-27010-00-RP	Cargo sling with dynamometer and outside mirrors (1,600 kg - 3,527 lb capacity) - Removable Parts			X		06-21010-00-RP	BFGoodrich Class 2 electrical hoist (272 kg - 90 m) - Removable Parts	06-21010-A
					X		06-21022-00-RP	BFGoodrich Class 1 electrical hoist (272 kg - 90 m) - Removable Parts	06-21022-A
					X		06-24002-00-RP	Rappelling (ropes are not included) - Removable Parts	06-24002-A
					X		07-81001-00-CI	5-seat VIP installation	07-81001-A
					X		07-81002-00-CI	6-seat VIP installation (2+4)	07-81002-A
					X		07-81003-00-CI	7-seat VIP installation	07-81003-A
					X		07-81019-00-CI	6-seat VIP installation (3+3)	07-81019-A
						X	06-27010-00-FP	Cargo sling with dynamometer and outside mirrors (1,600 kg - 3,527 lb capacity) - Fixed Parts	06-27010-A
06-31009-A	06-31009-00-RP	Electrical hailer with siren system – Removable Parts			X		06-24002-00-RP	Rappelling (ropes are not included) - Removable Parts	06-24002-A
						X	06-31009-00-FP	Electrical hailer with siren system – Fixed Parts	06-31009-A
06-45009-A	06-45009-00-FP	Spectrolab SX-16 searchlight - Fixed Parts	X				06-45034-00-FP	Spectrolab SX-5 searchlight - Fixed Parts	06-45034-A
06-45009-A	06-45009-00-RP	Spectrolab SX-16 searchlight - Removable Parts	X				06-45038-00-FP	Spectrolab SX-16 searchlight with infrared in-flight changeover - Fixed Parts	06-45038-A
			X				06-45034-00-FP	Spectrolab SX-5 searchlight - Fixed Parts	06-45034-A
			X				06-45038-00-FP	Spectrolab SX-16 searchlight with infrared in-flight changeover - Fixed Parts	06-45038-A
				X			06-24002-00-RP	Rappelling (ropes are not included) - Removable Parts	06-24002-A
				X			06-45009-00-FP	Spectrolab SX-16 searchlight - Fixed Parts	06-45009-A
					X				
06-45029-A	06-45029-00-CI	Infrared filter for Spectrolab SX-16 searchlight				X	06-45009-00-RP	Spectrolab SX-16 searchlight - Removable Parts	06-45009-A
06-45034-A	06-45034-00-FP	Spectrolab SX-5 searchlight - Fixed Parts	X				06-45009-00-FP	Spectrolab SX-16 searchlight - Fixed Parts	06-45009-A
			X				06-45038-00-FP	Spectrolab SX-16 searchlight with infrared in-flight changeover - Fixed Parts	06-45038-A
			X				06-45009-00-FP	Spectrolab SX-16 searchlight - Fixed Parts	06-45009-A
			X				06-45038-00-FP	Spectrolab SX-16 searchlight with infrared in-flight changeover - Fixed Parts	06-45038-A
				X			06-24002-00-RP	Rappelling (ropes are not included) – Removable Parts	06-24002-A
					X		06-45034-00-FP	Spectrolab SX-5 searchlight - Fixed Parts	06-45034-A
06-45037-A	06-45037-00-CI	Infrared filter for Spectrolab SX-5 searchlight				X	06-45034-00-RP	Spectrolab SX-5 searchlight - Removable Parts	06-45034-A

The data set forth in this document are general in nature and for information purposes only.

For performance data and operating limitations, reference must be made to the approved flight manual and all appropriate documents.

Document Reference	Commercial Reference	Installation	Nature of the Constraint				Commercial Reference	Installation	Document Reference
			EXL	NSF	NSU	REQ			
06-45038-A	06-45038-00-FP	Spectrolab SX-16 searchlight with infrared in-flight changeover - Fixed Parts	X				06-45009-00-FP	Spectrolab SX-16 searchlight - Fixed Parts	06-45009-A
	06-45038-00-RP	Spectrolab SX-16 searchlight with infrared in-flight changeover - Removable Parts	X				06-45034-00-FP	Spectrolab SX-5 searchlight - Fixed Parts	06-45034-A
			X				06-45009-00-FP	Spectrolab SX-16 searchlight - Fixed Parts	06-45009-A
			X				06-45034-00-FP	Spectrolab SX-5 searchlight - Fixed Parts	06-45034-A
					X		06-24002-00-RP	Rappelling (ropes are not included) – Removable Parts	06-24002-A
				X		06-45038-00-FP	Spectrolab SX-16 searchlight with infrared in-flight changeover - Fixed Parts	06-45038-A	
06-61020-A	06-61020-00-RP	Emergency floatation gear with automatic percussion - Removable Parts				X	06-61020-00-FP	Emergency floatation gear with automatic percussion - Fixed Parts	06-61020-A
06-62002-A	06-62002-00-FP	Aerazur life-raft installation – Fixed Parts	X				05-42026-00-CI	Air conditioning system (split)	05-42026-A
	06-62002-00-RP	Aerazur life-raft installation – Removable Parts	X				07-25011-00-CI	8-seat "Executive" installation with sound-proofing and carpeting	07-25011-A
			X				07-30003-00-CI	Comfort upholstery with improved sound-proofing and carpeting	07-30003-A
			X				07-81001-00-CI	5-seat VIP installation	07-81001-A
			X				07-81002-00-CI	6-seat VIP installation (2+4)	07-81002-A
			X				07-81003-00-CI	7-seat VIP installation	07-81003-A
			X				07-81019-00-CI	6-seat VIP installation (3+3)	07-81019-A
			X				05-42026-00-CI	Air conditioning system (split)	05-42026-A
			X				07-25011-00-CI	8-seat "Executive" installation with sound-proofing and carpeting	07-25011-A
			X				07-30003-00-CI	Comfort upholstery with improved sound-proofing and carpeting	07-30003-A
			X				07-81001-00-CI	5-seat VIP installation	07-81001-A
			X				07-81002-00-CI	6-seat VIP installation (2+4)	07-81002-A
			X				07-81003-00-CI	7-seat VIP installation	07-81003-A
			X				07-81019-00-CI	6-seat VIP installation (3+3)	07-81019-A
				X			07-71015-00-RP	Casualty-carrying installation for 4 stretchers (excluding stretchers) – Removable Parts	07-71015-A
					X		07-74004-00-CI	Stretchers for "Casualty-carrying installation for 4 stretchers" (Qty 4)	07-74004-A
						X	06-62002-00-FP	Aerazur life-raft installation – Fixed Parts	06-62002-A
06-66012-A	06-66012-00-CI	Helicopter Emergency Egress Lighting (HEEL)	X				07-81001-00-CI	5-seat VIP installation	07-81001-A
			X				07-81002-00-CI	6-seat VIP installation (2+4)	07-81002-A
			X				07-81003-00-CI	7-seat VIP installation	07-81003-A
			X				07-81019-00-CI	6-seat VIP installation (3+3)	07-81019-A

The data set forth in this document are general in nature and for information purposes only.

For performance data and operating limitations, reference must be made to the approved flight manual and all appropriate documents.

Document Reference	Commercial Reference	Installation	Nature of the Constraint				Commercial Reference	Installation	Document Reference
			EXL	NSF	NSU	REQ			
06-67012-A	06-67012-00-CI	Emergency locator Transmitter KANNAD 406-AF	X				06-67012-02-CI	Emergency locator Transmitter KANNAD 406-AF with GPS connection	06-67012-A
06-67012-A	06-67012-02-CI	Emergency locator Transmitter KANNAD 406-AF with GPS connection	X				06-67012-00-CI	Emergency locator Transmitter KANNAD 406-AF	06-67012-A
06-81008-A	06-81008-00-FP	Fire-fighting "BAMBI BUCKET" (910 litres) - Fixed Parts	X				05-82021-00-FP	Fuel jettison system – Fixed Parts	05-82021-A
	06-81008-00-RP	Fire-fighting "BAMBI BUCKET" (910 litres) - Removable Parts	X				05-82021-00-FP	Fuel jettison system – Fixed Parts	05-82021-A
					X		06-21010-00-RP	BFGoodrich Class 2 electrical hoist (272 kg - 90 m) - Removable Parts	06-21010-A
					X		06-21022-00-RP	BFGoodrich Class 1 electrical hoist (272 kg - 90 m) - Removable Parts	06-21022-A
					X		06-24002-00-RP	Rappelling (ropes are not included) - Removable Parts	06-24002-A
						X	06-81008-00-FP	Fire-fighting "BAMBI BUCKET" (910 litres) - Fixed Parts	06-81008-A
07-25002-A	07-25002-00-CI	12 seat lay-out complement	X				07-25009-00-CI	11 seat lay-out complement	07-25009-A
			X				07-25011-00-CI	8-seat "Executive" installation with sound-proofing and carpeting	07-25011-A
			X				07-30003-00-CI	Comfort upholstery with improved sound-proofing and carpeting	07-30003-A
			X				07-81001-00-CI	5-seat VIP installation	07-81001-A
			X				07-81002-00-CI	6-seat VIP installation (2+4)	07-81002-A
			X				07-81003-00-CI	7-seat VIP installation	07-81003-A
			X				07-81019-00-CI	6-seat VIP installation (3+3)	07-81019-A
				X			05-84003-00-CI	Ferrying tank (460 litres - 121 US gal.)	05-84003-A
				X			07-71015-00-RP	Casualty-carrying installation for 4 stretchers (excluding stretchers) – Removable Parts	07-71015-A
					X		07-74004-00-CI	Stretchers for "Casualty-carrying installation for 4 stretchers" (Qty 4)	07-74004-A
						X	06-21010-00-RP	BFGoodrich Class 2 electrical hoist (272 kg - 90 m) - Removable Parts	06-21010-A
						X	06-21022-00-RP	BFGoodrich Class 1 electrical hoist (272 kg - 90 m) - Removable Parts	06-21022-A
						X	06-24002-00-RP	Rappelling (ropes are not included) - Removable Parts	06-24002-A
07-25009-A	07-25009-00-CI	11 seat lay-out complement	X				07-25002-00-CI	12 seat lay-out complement	07-25002-A
			X				07-25011-00-CI	8-seat "Executive" installation with sound-proofing and carpeting	07-25011-A
			X				07-30003-00-CI	Comfort upholstery with improved sound-proofing and carpeting	07-30003-A
			X				07-81001-00-CI	5-seat VIP installation	07-81001-A
			X				07-81002-00-CI	6-seat VIP installation (2+4)	07-81002-A
			X				07-81003-00-CI	7-seat VIP installation	07-81003-A
			X				07-81019-00-CI	6-seat VIP installation (3+3)	07-81019-A
				X			05-84003-00-CI	Ferrying tank (460 litres - 121 US gal.)	05-84003-A
				X			07-71015-00-RP	Casualty-carrying installation for 4 stretchers (excluding stretchers) – Removable Parts	07-71015-A

The data set forth in this document are general in nature and for information purposes only.

For performance data and operating limitations, reference must be made to the approved flight manual and all appropriate documents.

Document Reference	Commercial Reference	Installation	Nature of the Constraint				Commercial Reference	Installation	Document Reference
			EXL	NSF	NSU	REQ			
	07-25009-00-CI (continued)	11 seat lay-out complement (continued)		X			07-74004-00-CI Stretchers for "Casualty-carrying installation for 4 stretchers" (Qty 4)	07-74004-A	
					X		06-21010-00-RP BFGoodrich Class 2 electrical hoist (272 kg - 90 m) - Removable Parts	06-21010-A	
					X		06-21022-00-RP BFGoodrich Class 1 electrical hoist (272 kg - 90 m) - Removable Parts	06-21022-A	
					X		06-24002-00-RP Rappelling (ropes are not included) - Removable Parts	06-24002-A	
07-25011-A	07-25011-00-CI	8-seat "Executive" installation with sound-proofing and carpeting	X				06-62002-00-FP Aerazur life-raft installation - Fixed Parts	06-62002-A	
			X				07-25002-00-CI 12 seat lay-out complement	07-25002-A	
			X				07-25009-00-CI 11 seat lay-out complement	07-25009-A	
			X				07-30003-00-CI Comfort upholstery with improved sound-proofing and carpeting	07-30003-A	
			X				07-71015-00-FP Casualty-carrying installation for 4 stretchers (excluding stretchers) - Fixed Parts	07-71015-A	
			X				07-81001-00-CI 5-seat VIP installation	07-81001-A	
			X				07-81002-00-CI 6-seat VIP installation (2+4)	07-81002-A	
			X				07-81003-00-CI 7-seat VIP installation	07-81003-A	
			X				07-81019-00-CI 6-seat VIP installation (3+3)	07-81019-A	
				X			05-84003-00-CI Ferrying tank (460 litres - 121 US gal.)	05-84003-A	
				X			06-21010-00-RP BFGoodrich Class 2 electrical hoist (272 kg - 90 m) - Removable Parts	06-21010-A	
				X			06-21022-00-RP BFGoodrich Class 1 electrical hoist (272 kg - 90 m) - Removable Parts	06-21022-A	
				X			06-24002-00-RP Rappelling (ropes are not included) - Removable Parts	06-24002-A	
			X				07-74004-00-CI Stretchers for "Casualty-carrying installation for 4 stretchers" (Qty 4)	07-74004-A	
07-25034-A	07-25034-00-CI	4 points harnesses for 11 seat lay-out complement	X				07-25050-00-CI 4 points harnesses for 12 seat lay-out complement	07-25050-A	
					X		07-25009-00-CI 11 seat lay-out complement	07-25009-A	
07-25050-A	07-25050-00-CI	4 points harnesses for 12 seat lay-out complement	X				07-25034-00-CI 4 points harnesses for 11 seat lay-out complement	07-25034-A	
					X		07-25002-00-OCI 12 seat lay-out complement	07-25002-A	
07-30003-A	07-30003-00-CI	Comfort upholstery with improved sound-proofing and carpeting	X				06-62002-00-FP Aerazur life-raft installation - Fixed Parts	06-62002-A	
			X				07-25002-00-CI 12 seat lay-out complement	07-25002-A	
			X				07-25009-00-CI 11 seat lay-out complement	07-25009-A	
			X				07-25011-00-CI 8-seat "Executive" installation with sound-proofing and carpeting	07-25011-A	
			X				07-71015-00-FP Casualty-carrying installation for 4 stretchers (excluding stretchers) - Fixed Parts	07-71015-A	
			X				07-81001-00-CI 5-seat VIP installation	07-81001-A	
			X				07-81002-00-CI 6-seat VIP installation (2+4)	07-81002-A	
			X				07-81003-00-CI 7-seat VIP installation	07-81003-A	
			X				07-81019-00-CI 6-seat VIP installation (3+3)	07-81019-A	

The data set forth in this document are general in nature and for information purposes only.

For performance data and operating limitations, reference must be made to the approved flight manual and all appropriate documents.

Document Reference	Commercial Reference	Installation	Nature of the Constraint				Commercial Reference	Installation	Document Reference
			EXL	NSF	NSU	REQ			
	07-30003-00-CI (continued)	Comfort upholstery with improved sound-proofing and carpeting (continued)		X			05-84003-00-CI Ferrying tank (460 litres - 121 US gal.)	05-84003-A	
				X			06-21010-00-RP BFGoodrich Class 2 electrical hoist (272 kg - 90 m) - Removable Parts	06-21010-A	
				X			06-21022-00-RP BFGoodrich Class 1 electrical hoist (272 kg - 90 m) - Removable Parts	06-21022-A	
				X			07-74004-00-CI Stretchers for "Casualty-carrying installation for 4 stretchers" (Qty 4)	07-74004-A	
07-50010-A	07-50010-00-CI	2 hinged passengers doors with 2 rear doors extensions (instead of the standard sliding doors)	X				05-31008-00-CI Sliding window on the rear enlarged bubble sliding door - Right Hand side	05-31008-A	
			X				05-31009-00-CI Sliding window on the rear enlarged bubble sliding door - Left Hand side	05-31009-A	
			X				06-21010-00-FP BFGoodrich Class 2 electrical hoist (272 kg - 90 m) - Fixed Parts	06-21010-A	
			X				06-21022-00-FP BFGoodrich Class 2 electrical hoist (272 kg - 90 m) - Removable Parts	06-21022-A	
			X				06-24002-00-FP Rappelling (ropes are not included) - Fixed Parts	06-24002-A	
07-71015-A	07-71015-00-FP	Casualty-carrying installation for 4 stretchers (excluding stretchers) - Fixed Parts	X				07-25011-00-CI 8-seat "Executive" installation with sound-proofing and carpeting	07-25011-A	
			X				07-30003-00-CI Comfort upholstery with improved sound-proofing and carpeting	07-30003-A	
			X				07-81001-00-CI 5-seat VIP installation	07-81001-A	
			X				07-81002-00-CI 6-seat VIP installation (2+4)	07-81002-A	
			X				07-81003-00-CI 7-seat VIP installation	07-81003-A	
			X				07-81019-00-CI 6-seat VIP installation (3+3)	07-81019-A	
	07-71015-00-RP	Casualty-carrying installation for 4 stretchers (excluding stretchers) - Removable Parts	X				07-25011-00-CI 8-seat "Executive" installation with sound-proofing and carpeting	07-25011-A	
			X				07-30003-00-CI Comfort upholstery with improved sound-proofing and carpeting	07-30003-A	
			X				07-81001-00-CI 5-seat VIP installation	07-81001-A	
			X				07-81002-00-CI 6-seat VIP installation (2+4)	07-81002-A	
			X				07-81003-00-CI 7-seat VIP installation	07-81003-A	
			X				07-81019-00-CI 6-seat VIP installation (3+3)	07-81019-A	
				X			05-84003-00-CI Ferrying tank (460 litres - 121 US gal.)	05-84003-A	
				X			06-21010-00-RP BFGoodrich Class 2 electrical hoist (272 kg - 90 m) - Removable Parts	06-21010-A	
				X			06-21022-00-RP BFGoodrich Class 1 electrical hoist (272 kg - 90 m) - Removable Parts	06-21022-A	
				X			06-24002-00-RP Rappelling (ropes are not included) - Removable Parts	06-24002-A	
				X			06-62002-00-RP Aerazur life-raft installation - Removable Parts	06-62002-A	
				X			07-25002-00-CI 12 seat lay-out complement	07-25002-A	
				X			07-25009-00-CI 11 seat lay-out complement	07-25009-A	

The data set forth in this document are general in nature and for information purposes only.

For performance data and operating limitations, reference must be made to the approved flight manual and all appropriate documents.

Document Reference	Commercial Reference	Installation	Nature of the Constraint				Commercial Reference	Installation	Document Reference			
			EXL	NSF	NSU	REQ						
07-74004-A	07-74004-00-CI	Stretchers for "Casualty-carrying installation for 4 stretchers" (Qty 4)		X			05-84003-00-CI	Ferrying tank (460 litres - 121 US gal.)	05-84003-A			
				X			06-21010-00-RP	BFGoodrich Class 2 electrical hoist (272 kg - 90 m) - Removable Parts	06-21010-A			
				X			06-21022-00-RP	BFGoodrich Class 1 electrical hoist (272 kg - 90 m) - Removable Parts	06-21022-A			
				X			06-24002-00-RP	Rappelling (ropes are not included) - Removable Parts	06-24002-A			
				X			06-62002-00-RP	Aerazur life-raft installation - Removable Parts	06-62002-A			
				X			07-25002-00-CI	12 seat lay-out complement	07-25002-A			
				X			07-25009-00-CI	11 seat lay-out complement	07-25009-A			
				X			07-25011-00-CI	8-seat "Executive" installation with sound-proofing and carpeting	07-25011-A			
				X			07-30003-00-CI	Comfort upholstery with improved sound-proofing and carpeting	07-30003-A			
						X		07-71015-00-RP	Casualty-carrying installation for 4 stretchers (excluding stretchers) - Removable Parts	07-71015-A		
			07-81001-A	07-81001-00-CI	5-seat VIP installation	X				06-21010-00-FP	BFGoodrich Class 2 electrical hoist (272 kg - 90 m) - Fixed Parts	06-21010-A
						X				06-21022-00-FP	BFGoodrich Class 1 electrical hoist (272 kg - 90 m) - Fixed Parts	06-21022-A
						X				06-24002-00-FP	Rappelling (ropes are not included) - Fixed Parts	06-24002-A
X							06-62002-00-FP	Aerazur life-raft installation - Fixed Parts	06-62002-A			
X							06-66012-00-CI	Helicopter Emergency Egress Lighting (HEEL)	06-66012-A			
X							07-25002-00-CI	12 seat lay-out complement	07-25002-A			
X							07-25009-00-CI	11 seat lay-out complement	07-25009-A			
X							07-25011-00-CI	8-seat "Executive" installation with sound-proofing and carpeting	07-25011-A			
X							07-30003-00-CI	Comfort upholstery with improved sound-proofing and carpeting	07-30003-A			
X							07-71015-00-FP	Casualty-carrying installation for 4 stretchers (excluding stretchers) - Fixed Parts	07-71015-A			
X							07-81002-00-CI	6-seat VIP installation (2+4)	07-81002-A			
X							07-81003-00-CI	7-seat VIP installation	07-81003-A			
X							07-81019-00-CI	6-seat VIP installation (3+3)	07-81019-A			
X							07-82005-00-CI	Headrest (Qty 8) & floor inserts for 8-seat face-to-face installation	07-82005-A			
						X		06-27010-00-RP	Cargo sling with dynamometer and outside mirrors (1,600 kg - 3,527 lb capacity) - Removable Parts	06-27010-A		
							X		07-50010-00-CI	2 hinged passengers doors with 2 rear doors extensions (instead of the standard sliding doors)	07-50010-A	
				X		08-17015-01-CI	Passenger interphone TEAM BA 1920 (for VIP installation)	08-17015-A				

The data set forth in this document are general in nature and for information purposes only.

For performance data and operating limitations, reference must be made to the approved flight manual and all appropriate documents.

Document Reference	Commercial Reference	Installation	Nature of the Constraint				Commercial Reference	Installation	Document Reference
			EXL	NSF	NSU	REQ			
	07-81001-00-CI (continued)	5-seat VIP installation (continued)				X	08-17016-00-CI Passenger interphone for active noise cancelling headsets 1 x NAT AA-36 + 2 x NAT AA-82	08-17016-A	
						X	08-18029-00-CI Active noise cancelling headset BOSE X	08-18029-A	
07-81002-A	07-81002-00-CI	6-seat VIP installation (2 + 4)	X				06-21010-00-FP BFGoodrich Class 2 electrical hoist (272 kg - 90 m) - Fixed Parts	06-21010-A	
			X				06-21022-00-FP BFGoodrich Class 1 electrical hoist (272 kg - 90 m) - Fixed Parts	06-21022-A	
			X				06-24002-00-FP Rappelling (ropes are not included) - Fixed Parts	06-24002-A	
			X				06-62002-00-FP Aerazur life-raft installation - Fixed Parts	06-62002-A	
			X				06-66012-00-CI Helicopter Emergency Egress Lighting (HEEL)	06-66012-A	
			X				07-25002-00-CI 12 seat lay-out complement	07-25002-A	
			X				07-25009-00-CI 11 seat lay-out complement	07-25009-A	
			X				07-25011-00-CI 8-seat "Executive" installation with sound-proofing and carpeting	07-25011-A	
			X				07-30003-00-CI Comfort upholstery with improved sound-proofing and carpeting	07-30003-A	
			X				07-71015-00-FP Casualty-carrying installation for 4 stretchers (excluding stretchers) - Fixed Parts	07-71015-A	
			X				07-81001-00-CI 5-seat VIP installation	07-81001-A	
			X				07-81003-00-CI 7-seat VIP installation	07-81003-A	
			X				07-81019-00-CI 6-seat VIP installation (3+3)	07-81019-A	
			X				07-82005-00-CI Headrest (Qty 8) & floor inserts for 8-seat face-to-face installation	07-82005-A	
					X		06-27010-00-RP Cargo sling with dynamometer and outside mirrors (1,600 kg - 3,527 lb capacity) - Removable Parts	06-27010-A	
					X		07-50010-00-CI 2 hinged passengers doors with 2 rear doors extensions (instead of the standard sliding doors)	07-50010-A	
					X		08-17015-01-CI Passenger interphone TEAM BA 1920 (for VIP installation)	08-17015-A	
					X		08-17016-00-CI Passenger interphone for active noise cancelling headsets 1 x NAT AA-36 + 2 x NAT AA-82	08-17016-A	
					X		08-18029-00-CI Active noise cancelling headset BOSE X	08-18029-A	
07-81003-A	07-81003-00-CI	7-seat VIP installation	X				06-21010-00-FP BFGoodrich Class 2 electrical hoist (272 kg - 90 m) - Fixed Parts	06-21010-A	
			X				06-21022-00-FP BFGoodrich Class 1 electrical hoist (272 kg - 90 m) - Fixed Parts	06-21022-A	
			X				06-24002-00-FP Rappelling (ropes are not included) - Fixed Parts	06-24002-A	
			X				06-62002-00-FP Aerazur life-raft installation - Fixed Parts	06-62002-A	
			X				06-66012-00-CI Helicopter Emergency Egress Lighting (HEEL)	06-66012-A	

The data set forth in this document are general in nature and for information purposes only.

For performance data and operating limitations, reference must be made to the approved flight manual and all appropriate documents.

Document Reference	Commercial Reference	Installation	Nature of the Constraint				Commercial Reference	Installation	Document Reference
			EXL	NSF	NSU	REQ			
	07-81003-00-CI (continued)	7-seat VIP installation (continued)	X				07-25002-00-CI	12 seat lay-out complement	07-25002-A
			X				07-25009-00-CI	11 seat lay-out complement	07-25009-A
			X				07-25011-00-CI	8-seat "Executive" installation with sound-proofing and carpeting	07-25011-A
			X				07-30003-00-CI	Comfort upholstery with improved sound-proofing and carpeting	07-30003-A
			X				07-71015-00-FP	Casualty-carrying installation for 4 stretchers (excluding stretchers) - Fixed Parts	07-71015-A
			X				07-81001-00-CI	5-seat VIP installation	07-81001-A
			X				07-81002-00-CI	6-seat VIP installation (2+4)	07-81002-A
			X				07-81019-00-CI	6-seat VIP installation (3+3)	07-81019-A
			X				07-82005-00-CI	Headrest (Qty 8) & floor inserts for 8-seat face-to-face installation	07-82005-A
						X	06-27010-00-RP	Cargo sling with dynamometer and outside mirrors (1,600 kg - 3,527 lb capacity) - Removable Parts	06-27010-A
						X	07-50010-00-CI	2 hinged passengers doors with 2 rear doors extensions (instead of the standard sliding doors)	07-50010-A
						X	08-17016-00-CI	Passenger interphone for active noise cancelling headsets 1 x NAT AA-36 + 2 x NAT AA-82	08-17016-A
						X	08-18029-00-CI	Active noise cancelling headset BOSE X	08-18029-A
07-81019-A			07-81019-00-CI	6-seat VIP installation (3 + 3)	X				06-21010-00-FP
	X						06-21022-00-FP	BFGoodrich Class 1 electrical hoist (272 kg - 90 m) - Fixed Parts	06-21022-A
	X						06-24002-00-FP	Rappelling (ropes are not included) - Fixed Parts	06-24002-A
	X						06-62002-00-FP	Aerazur life-raft installation - Fixed Parts	06-62002-A
	X						06-66012-00-CI	Helicopter Emergency Egress Lighting (HEEL)	06-66012-A
	X						07-25002-00-CI	12 seat lay-out complement	07-25002-A
	X						07-25009-00-CI	11 seat lay-out complement	07-25009-A
	X						07-25011-00-CI	8-seat "Executive" installation with sound-proofing and carpeting	07-25011-A
	X						07-30003-00-CI	Comfort upholstery with improved sound-proofing and carpeting	07-30003-A
	X						07-71015-00-FP	Casualty-carrying installation for 4 stretchers (excluding stretchers) - Fixed Parts	07-71015-A
	X						07-81001-00-CI	5-seat VIP installation	07-81001-A
	X						07-81002-00-CI	6-seat VIP installation (2+4)	07-81002-A
	X						07-81003-00-CI	7-seat VIP installation	07-81003-A
	X						07-82005-00-CI	Headrest (Qty 8) & floor inserts for 8-seat face-to-face installation	07-82005-A

The data set forth in this document are general in nature and for information purposes only.

For performance data and operating limitations, reference must be made to the approved flight manual and all appropriate documents.

Document Reference	Commercial Reference	Installation	Nature of the Constraint				Commercial Reference	Installation	Document Reference
			EXL	NSF	NSU	REQ			
	07-81019-00-CI (continued)	6-seat VIP installation (3 + 3) (continued)			X		06-27010-00-RP Cargo sling with dynamometer and outside mirrors (1,600 kg - 3,527 lb capacity) - Removable Parts	06-27010-A	
					X		07-50010-00-CI 2 hinged passengers doors with 2 rear doors extensions (instead of the standard sliding doors)	07-50010-A	
					X		08-17016-00-CI Passenger interphone for active noise cancelling headsets 1 x NAT AA-36 + 2 x NAT AA-82	08-17016-A	
					X		08-18029-00-CI Active noise cancelling headset BOSE X	08-18029-A	
07-82005-A	07-82005-00-CI	Headrest (Qty 8) & floor inserts for 8-seat face-to-face installation	X				07-81001-00-CI 5-seat VIP installation	07-81001-A	
			X				07-81002-00-CI 6-seat VIP installation (2+4)	07-81002-A	
			X				07-81003-00-CI 7-seat VIP installation	07-81003-A	
			X				07-81019-00-CI 6-seat VIP installation (3+3)	07-81019-A	
08-16019-A	08-16019-00-CI	Fourth control box 1976 for TEAM TB 31 ICS			X		08-16015-00-CI Third control box 1976 in cabin for TEAM TB 31 ICS	08-16015-A	
08-17015-A	08-17015-01-CI	Passenger interphone TEAM BA 1920 (for VIP installation)			X		07-81001-00-CI 5-seat VIP installation	07-81001-A	
					X		or 07-81002-00-CI 6-seat VIP installation	07-81002-A	
08-18029-A	08-18029-00-CI	Active noise cancelling headset BOSE X			X		08-17016-00-CI Passenger interphone for active noise cancelling headsets 1 x NAT AA-36 + 2 x NAT AA-82	08-17016-A	
08-31036-A	08-31036-00-CI	Weather radar Telephonics RDR 1400 C (displayed on MFD-255)	X				08-31038-00-CI Honeywell RDR 2000 weather radar (displayed on KMD-850 - not included)	08-31038-A	
08-31038-A	08-31038-00-CI	Honeywell RDR 2000 weather radar (displayed on KMD-850 - not included)	X				08-31036-00-CI Weather radar Telephonics RDR 1400 C (displayed on MFD-255)	08-31036-A	
					X		08-46029-00-CI Honeywell KMD 850 Jeppesen map	08-46029-A	
08-35019-A	08-35019-00-CI	TCAS Goodrich SKYWATCH HP 899 (displayed on KMD850 - not included)			X		08-46029-00-CI Honeywell KMD 850 Jeppesen map	08-46029-A	
08-38004-A	08-38004-00-CI	BFGoodrich WX1000E Stormscope (displayed on KMD850 - not included)			X		08-46029-00-CI Honeywell KMD 850 Jeppesen map	08-46029-A	
08-46022-A	08-46022-00-CI	Moving map Euroavionics EURONAV IV linked to GPS, and displayed on 10.4" MFD (MFD not included)	X				08-46029-00-CI Honeywell KMD 850 Jeppesen map	08-46029-A	
					X		08-65010-00-CI Skyquest 10,4" display	08-65010-A	
08-46029-A	08-46029-00-CI	Honeywell KMD 850 Jeppesen map	X				08-46022-00-CI Moving map Euroavionics EURONAV IV linked to GPS, and displayed on 10.4" MFD (MFD not included)	08-46022-A	
			X				08-65010-00-CI Skyquest 10,4" display	08-65010-A	
08-65010-A	08-65010-00-CI	Skyquest 10,4" display	X				08-46029-00-CI Honeywell KMD 850 Jeppesen map	08-46029-A	

The data set forth in this document are general in nature and for information purposes only.

For performance data and operating limitations, reference must be made to the approved flight manual and all appropriate documents.

Document Reference	Commercial Reference	Installation	Nature of the Constraint				Commercial Reference	Installation	Document Reference
			EXL	NSF	NSU	REQ			
08-83010-A	08-83010-00-CI	UMS - complement of SSCVFDR (usage functions)				X	08-81023-00-CI	Solid State Cockpit Voice & Flight Data Recorder Honeywell AR COMBI (2 hours CVR and 10 hours FDR recording)	08-81023-A
08-83012-A	08-83012-00-CI	HUMS - complement of UMS (health functions)				X	08-83010-00-CI	UMS - complement of SSCVFDR (usage functions)	08-83010-A
08-83023-A	08-83023-00-CI	QAR (Quick Access Recorder) for HOMP				X	08-81023-00-CI	Solid State Cockpit Voice & Flight Data Recorder Honeywell AR COMBI (2 hours CVR and 10 hours FDR recording)	08-81023-A

The data set forth in this document are general in nature and for information purposes only.

For performance data and operating limitations, reference must be made to the approved flight manual and all appropriate documents.

6 - Main performance

The following performance figures and charts are probable average values obtained with new engines. Unless otherwise specified, they are for the aircraft in "clean" configuration in zero wind, sea level, standard atmosphere conditions.

Performance on 2 engine

Gross Weight	kg	3,750	4,000	4,300	
	lb	8,267	8,818	9,480	
■ Max. speed, VNE	km/hr	306	296	287	
	kts	165	160	155	
■ Fast cruise speed	km/hr	279	274	269	
	kts	151	148	145	
■ Recommended cruise speed	km/hr	276	274	269	
	kts	149	148	145	
■ Fuel consumption at recommended cruise speed	kg/hr	309	313	314	
	lb/h	681	690	692	
■ Rate-of-climb	m/sec.	8.9	7.9	6.7	
	ft/min.	1,759	1,554	1,321	
■ Hover ceiling I.G.E. at Take-Off Power (6 ft)					
	● ISA	m	3,900	3,300	2,620
		ft	12,795	10,827	8,596
	● ISA + 20°C	m	3,150	2,530	1,810
		ft	10,335	8,300	5,938
■ Hover ceiling O.G.E. at Take-Off Power					
	● ISA	m	3,110	2,500	1,150
		ft	10,203	8,202	3,773
	● ISA + 20°C	m	2,320	1,685	310
		ft	7,610	5,527	1,017
■ Service ceiling (Vz = 0,5 m/sec. – 100 ft/min.)					
	● ISA	m	5,865	5,290	4,640
		ft	19,242	17,355	15,223
■ Maximum range (without fuel reserve, at recommended cruise speed)					
	● with standard tanks	km	827	811	792
		n.m	446	438	427
	● with optional auxiliary tank	km	963	945	923
		n.m	520	510	498
■ Maximum endurance [without reserve at 140 km/hr (75 kts)]					
	● with standard tanks	hr	4.3	4.2	4.1
	● with optional auxiliary tank	hr	5.0	4.9	4.75

The data set forth in this document are general in nature and for information purposes only.

For performance data and operating limitations, reference must be made to the approved flight manual and all appropriate documents.

Performance with external load (drag: 1 m²)

In external load carrying mission at maximum gross-weight of 4,300 kg - 9,480 lb

- Rate of climb 6.1 m/sec.
 1,200 ft/min.

Performance on 1 engine

Gross Weight	kg lb	3,750 8,267	4,000 8,818	4,300 9,480
■ Rate-of-climb at continuous OEI power	m/sec. ft/min.	4.6 905	3.8 748	2.9 570
■ Service ceiling (0.5 m/sec. - 100 ft/min.) continuous OEI power	m ft	3,125 10,252	2,515 8,259	1,820 5,971

Operating limitations

The aircraft is cleared to operate within the following altitude and temperature limitations:
(Refer to Flight Manual for complementary information)

- Maximum altitude (Standard Atmosphere conditions)
 - Take-off and landing 4,575 m - 15,000 ft (density-altitude)
 - Flight 6,096 m - 20,000 ft (pressure-altitude)

- Maximum temperature ISA + 35° C limited at + 50° C

- Minimum temperature - 40° C

Abbreviations

IGE:	In Ground Effect	TOP:	Take-Off Power
ISA:	International Standard Atmosphere	VNE:	Never Exceed Speed
MCP:	Maximum Continuous Power	VTOL:	Vertical Take-Off and Landing
OEI:	One Engine Inoperative	Vtoss:	Take-off Safety Speed
OGE:	Out of Ground Effect	Vy:	Optimum Climbing Speed
SL:	Sea Level	Vz:	Rate-of-Climb
TAS:	True Airspeed		

Units

nm:	nautical miles	hr:min:	hours:minutes
kts:	knots	kg	kilograms
ft/min:	feet/minute	lb:	pounds
m/sec:	meters per seconds	km:	kilometers
° C:	degrees Celsius		

The data set forth in this document are general in nature and for information purposes only.

For performance data and operating limitations, reference must be made to the approved flight manual and all appropriate documents.

Performance charts

The performance charts presented hereafter apply to an aircraft as per the standard definition.

■ Take-off weight in hover IGE (6 ft) on 2 engines at Maximum take-off power	page 38
■ Take-off weight in hover OGE on 2 engines at Maximum take-off power	page 39
■ Maximum Permissible Gross Weight on take-off from clear heliport Category A Vtoss : 65/75 kts – Vy : 75 kts.....	page 40
■ Maximum Permissible Gross Weight on take-off from helipad Category A	page 41
■ Rate of climb in oblique flight on 2 engines at maximum continuous power ISA; T.A.S. = 75 kts	page 42
■ Rate of climb in oblique flight on 2 engines at maximum continuous power ISA+ 20°C; T.A.S. = 75 kts	page 43
■ Rate of climb in oblique flight on 1 engine OEI unlimited ISA; T.A.S. = 75 kts	page 44
■ Rate of climb in oblique flight on 1 engine OEI unlimited ISA + 20°C; T.A.S. = 75 kts	page 45
■ Hourly fuel consumption in level flight Pressure-altitude = 0 ft, ISA (temperature = 15°C)	page 46
■ Hourly fuel consumption in level flight Pressure-altitude = 5000 ft, ISA (temperature = 5.1°C)	page 47
■ Hourly fuel consumption in level flight Pressure-altitude = 10000 ft, ISA (temperature = -4.8°C)	page 48
■ Hourly fuel consumption in level flight Pressure-altitude = 0 ft, ISA + 20°C (temperature = 35°C)	page 49
■ Hourly fuel consumption in level flight Pressure-altitude = 5000 ft, ISA + 20°C (temperature = 25°C)	page 50
■ Hourly fuel consumption in level flight Pressure-altitude = 10000 ft, ISA + 20°C (temperature = 15.2°C)	page 51
■ Payload/range chart Pressure-altitude = sea level; ISA	page 52
■ Payload/range chart Pressure-altitude = sea level; ISA + 20°C	page 53

The data set forth in this document are general in nature and for information purposes only.

For performance data and operating limitations, reference must be made to the approved flight manual and all appropriate documents.

TAKE-OFF WEIGHT IN HOVER I.G.E. (6 ft)
on 2 engines at Maximum Take-Off Power

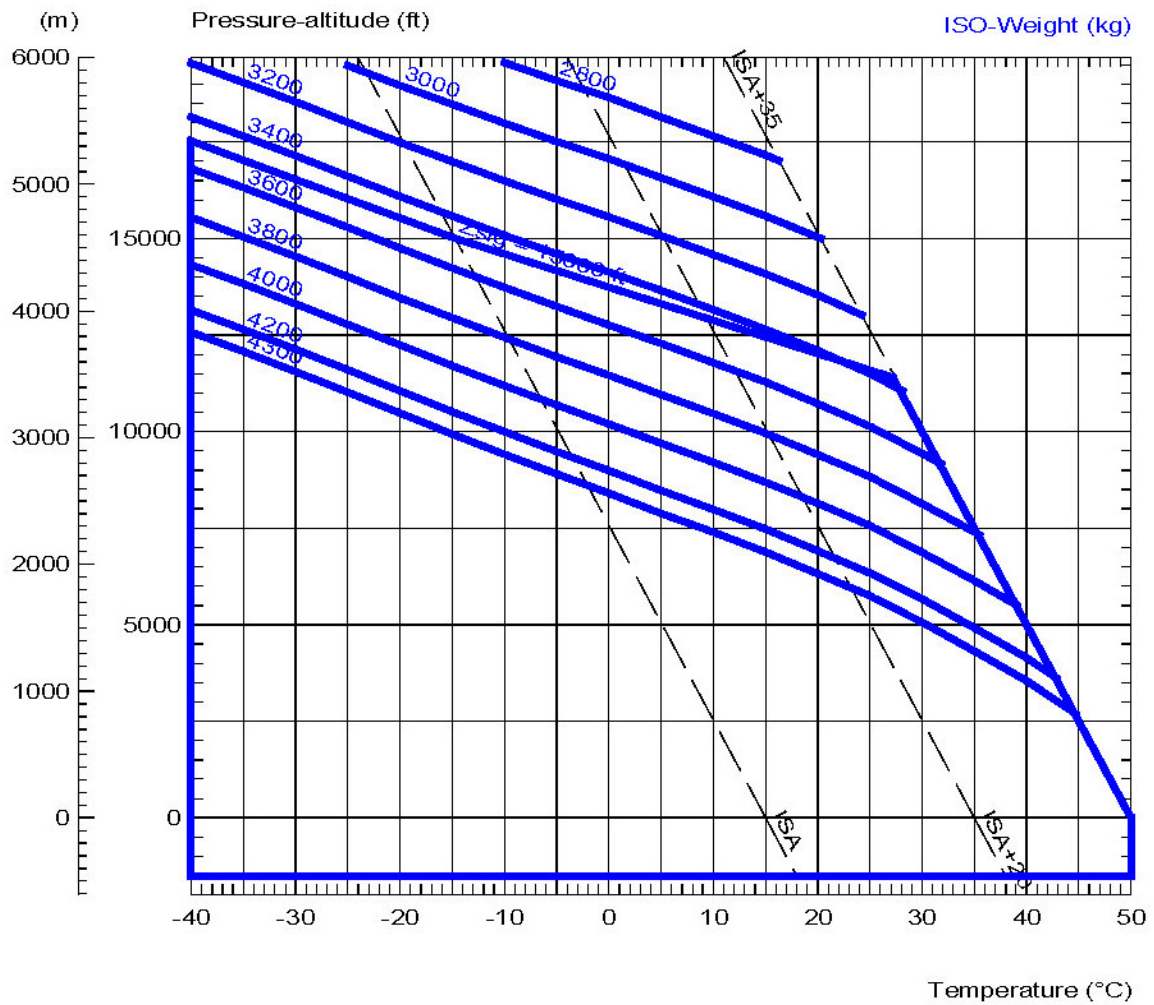

The data set forth in this document are general in nature and for information purposes only.
For performance data and operating limitations, reference must be made to the approved flight manual and all appropriate documents.

TAKE-OFF WEIGHT IN HOVER O.G.E.

on 2 engines at Maximum Take-Off Power

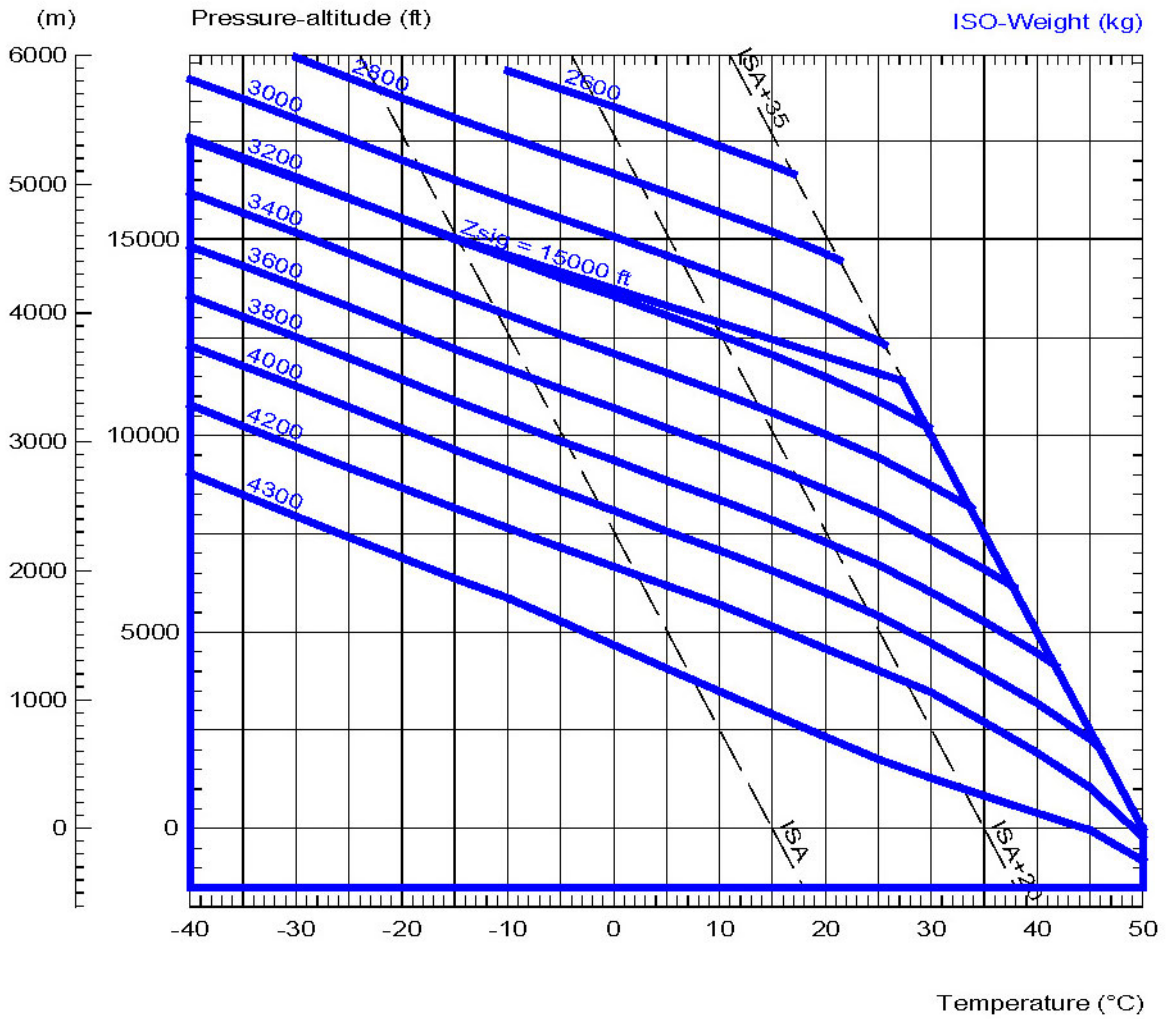

The data set forth in this document are general in nature and for information purposes only.

For performance data and operating limitations, reference must be made to the approved flight manual and all appropriate documents.

**MAXIMUM PERMISSIBLE GROSS WEIGHT ON TAKE-OFF
FROM CLEAR HELIPORT**

Category A
Vtoss: 65/75 kts - Vy: 75 kts

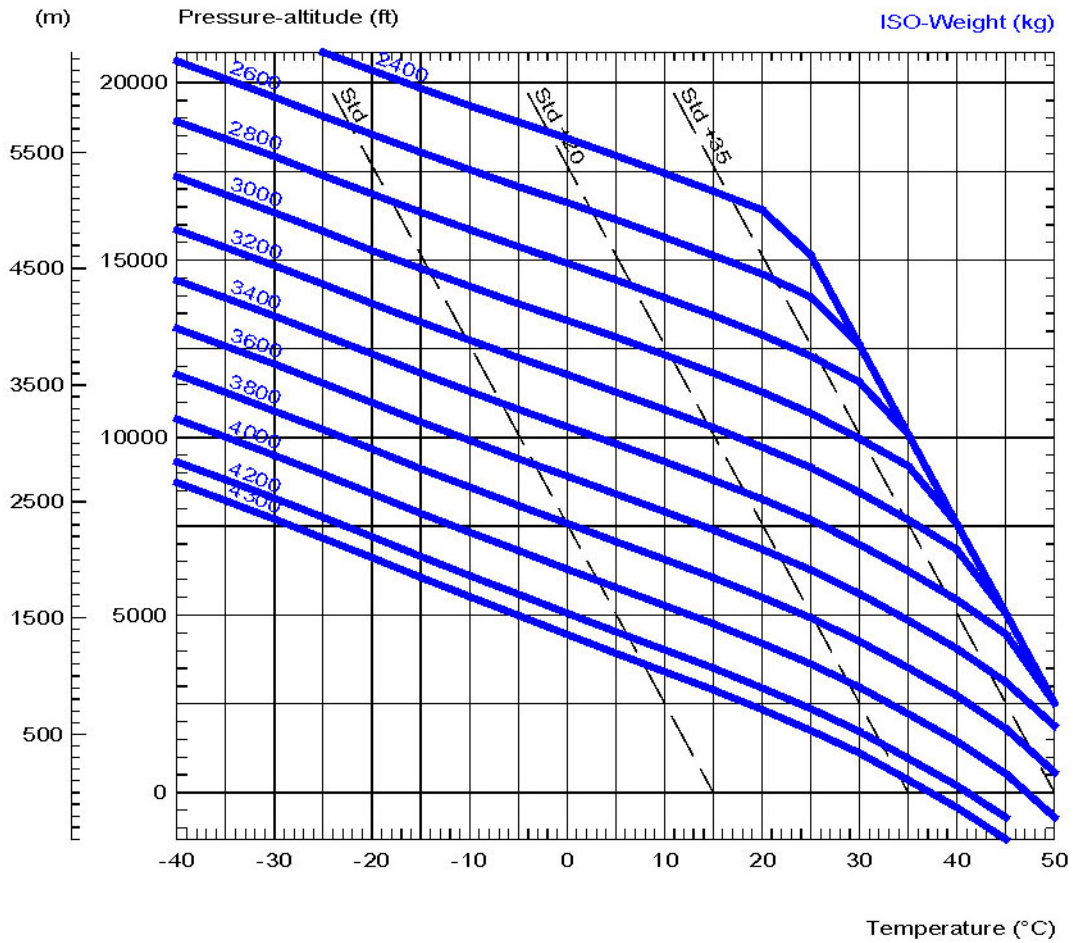

The data set forth in this document are general in nature and for information purposes only.

For performance data and operating limitations, reference must be made to the approved flight manual and all appropriate documents.

**MAXIMUM PERMISSIBLE GROSS WEIGHT ON TAKE-OFF
FROM HELIPAD**

Category A

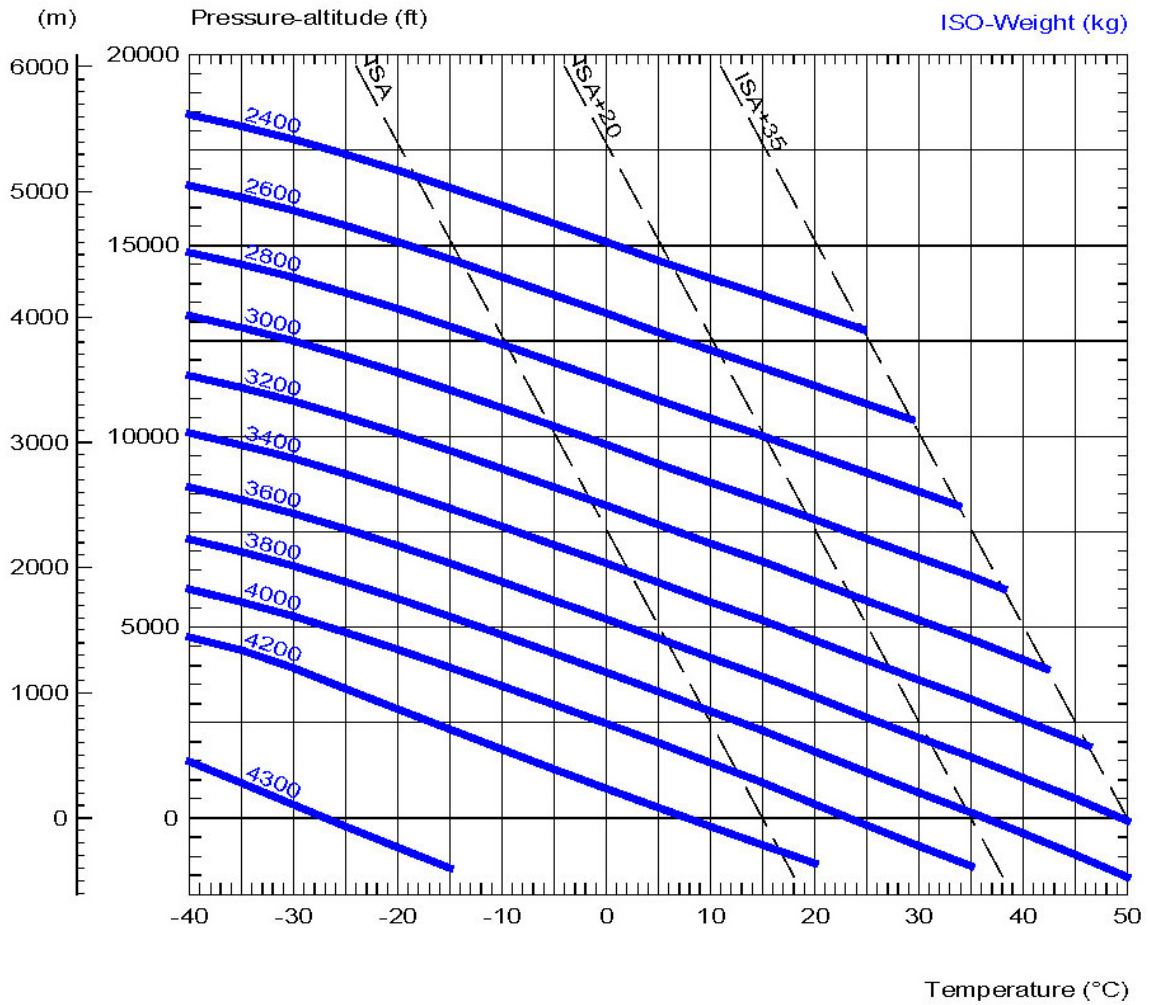

The data set forth in this document are general in nature and for information purposes only.

For performance data and operating limitations, reference must be made to the approved flight manual and all appropriate documents.

RATE OF CLIMB IN OBLIQUE FLIGHT

on 2 engines at Maximum Continuous Power
ISA; T.A.S. = 75 kts

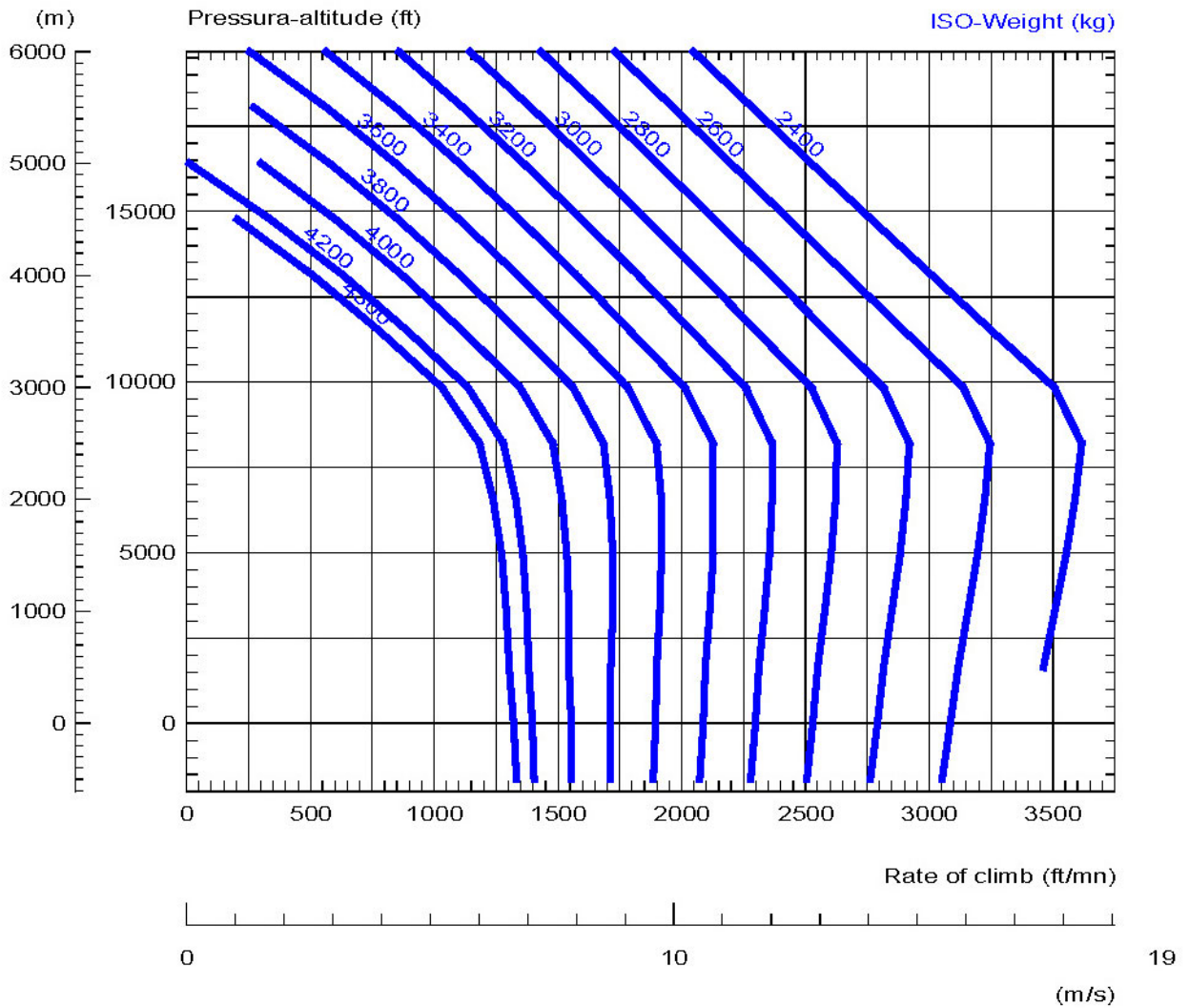

The data set forth in this document are general in nature and for information purposes only.

For performance data and operating limitations, reference must be made to the approved flight manual and all appropriate documents.

RATE OF CLIMB IN OBLIQUE FLIGHT

on 2 engines at Maximum Continuous Power
ISA+20 °C; T.A.S. = 75 kts

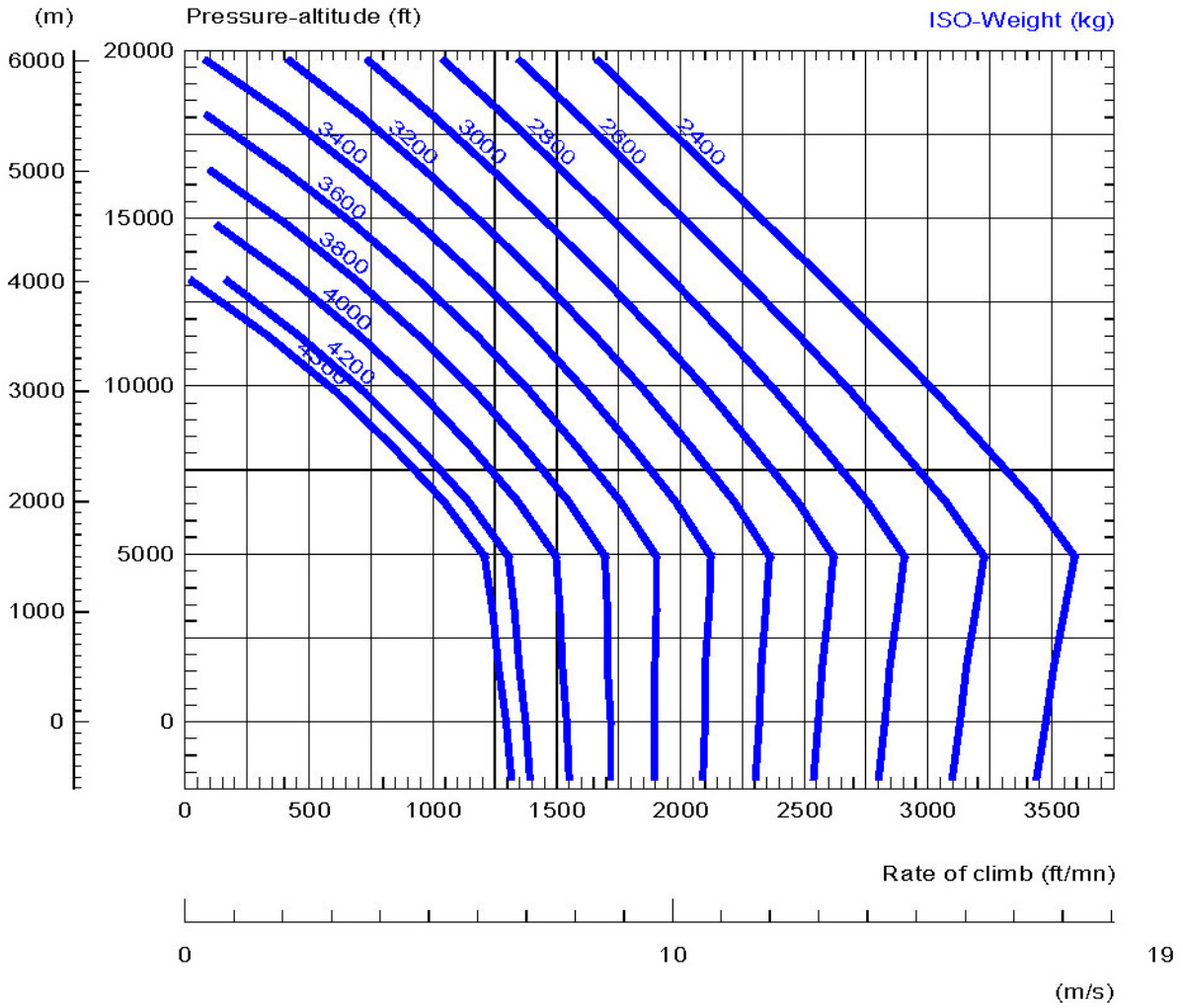

The data set forth in this document are general in nature and for information purposes only.

For performance data and operating limitations, reference must be made to the approved flight manual and all appropriate documents.

RATE OF CLIMB IN OBLIQUE FLIGHT

on 1 engine OEI unlimited
ISA; T.A.S. = 75 kts

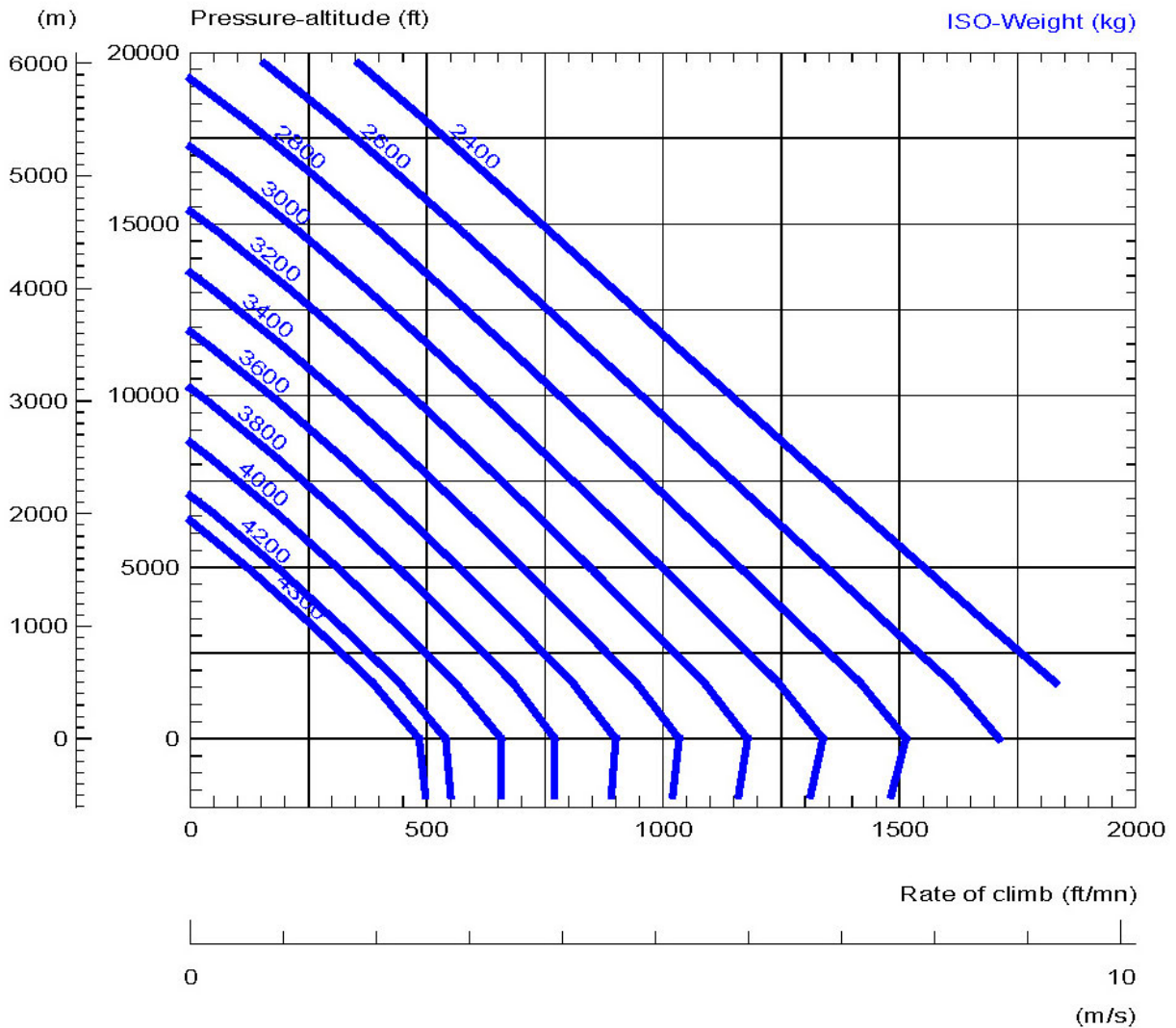

The data set forth in this document are general in nature and for information purposes only.

For performance data and operating limitations, reference must be made to the approved flight manual and all appropriate documents.

RATE OF CLIMB IN OBLIQUE FLIGHT

on 1 engine OEI unlimited
ISA+20°C; T.A.S. = 75 kts

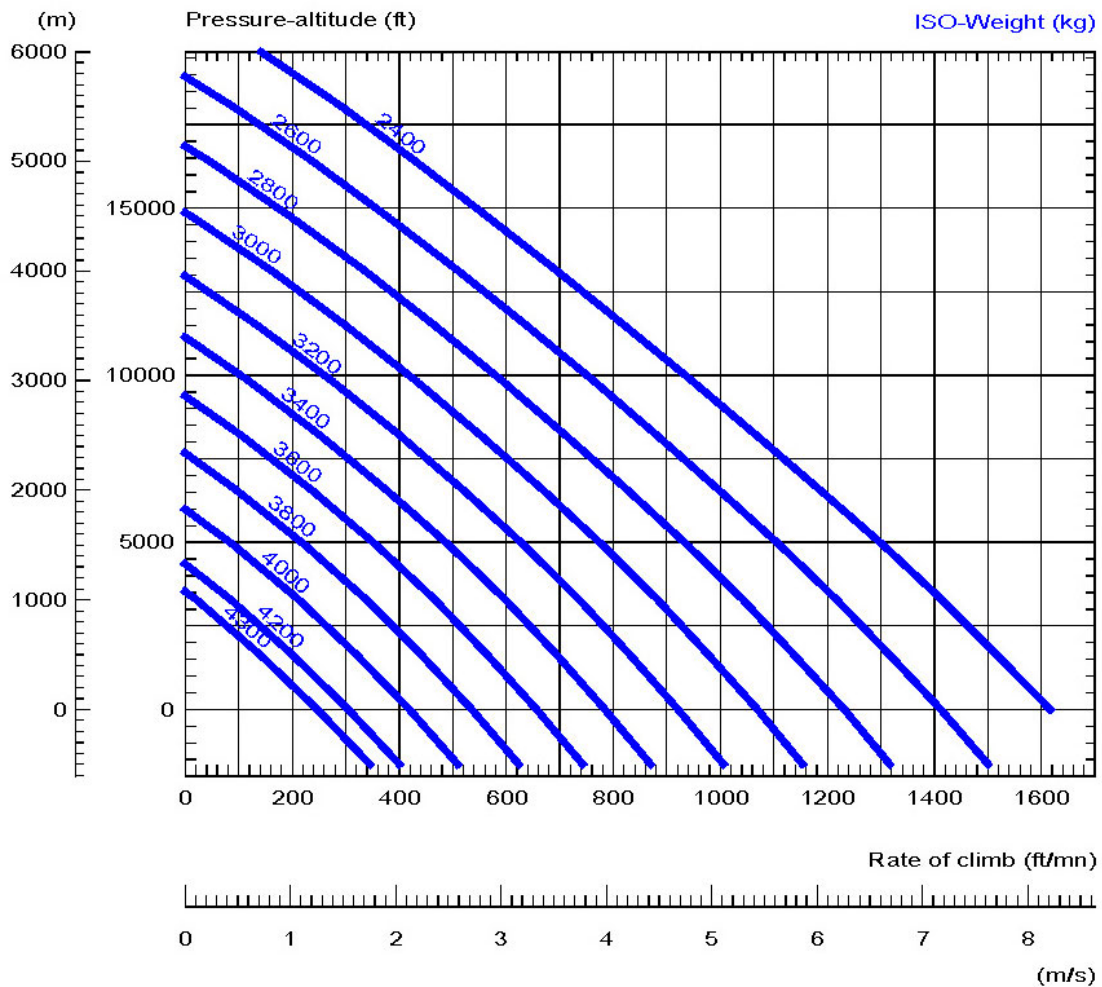

The data set forth in this document are general in nature and for information purposes only.

For performance data and operating limitations, reference must be made to the approved flight manual and all appropriate documents.

HOURLY FUEL CONSUMPTION IN LEVEL FLIGHT

Pressure-altitude = 0 ft ; ISA (Temperature = 15 °C)

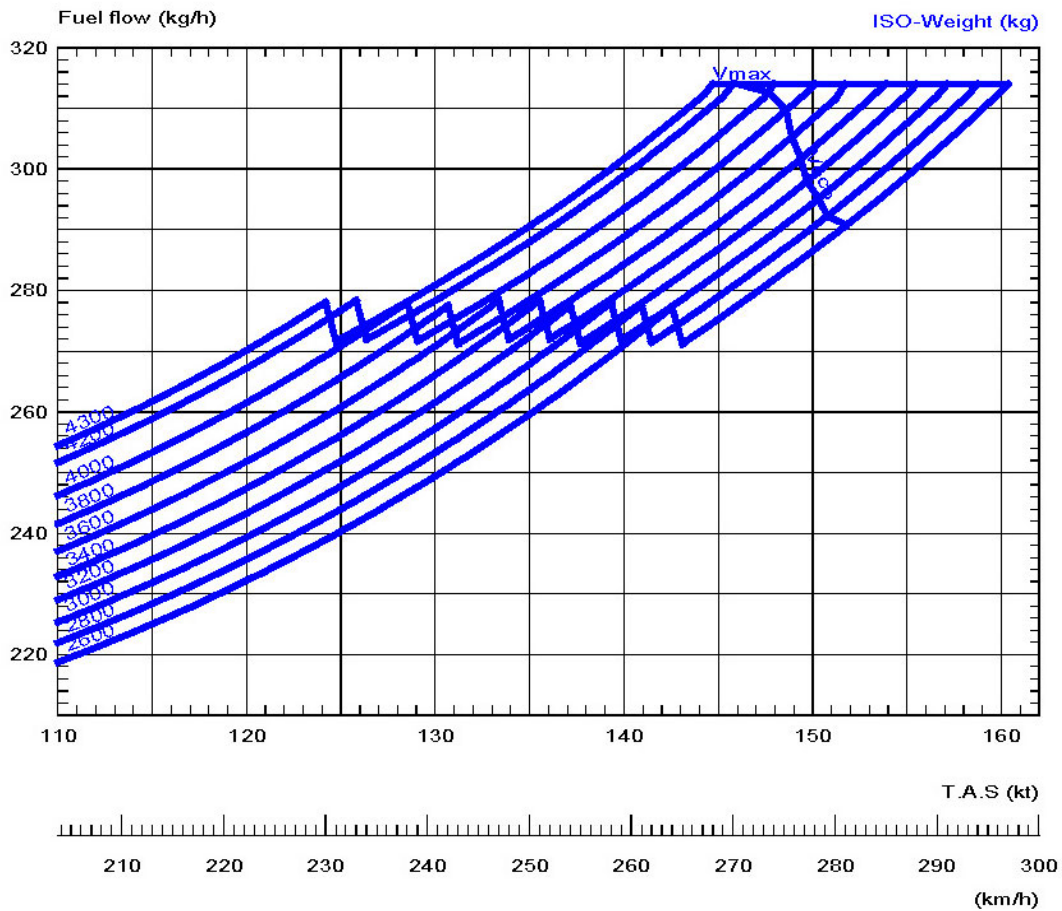

The data set forth in this document are general in nature and for information purposes only.

For performance data and operating limitations, reference must be made to the approved flight manual and all appropriate documents.

HOURLY FUEL CONSUMPTION IN LEVEL FLIGHT

Pressure-altitude = 5000 ft ; ISA (Temperature = 5.1 °C)

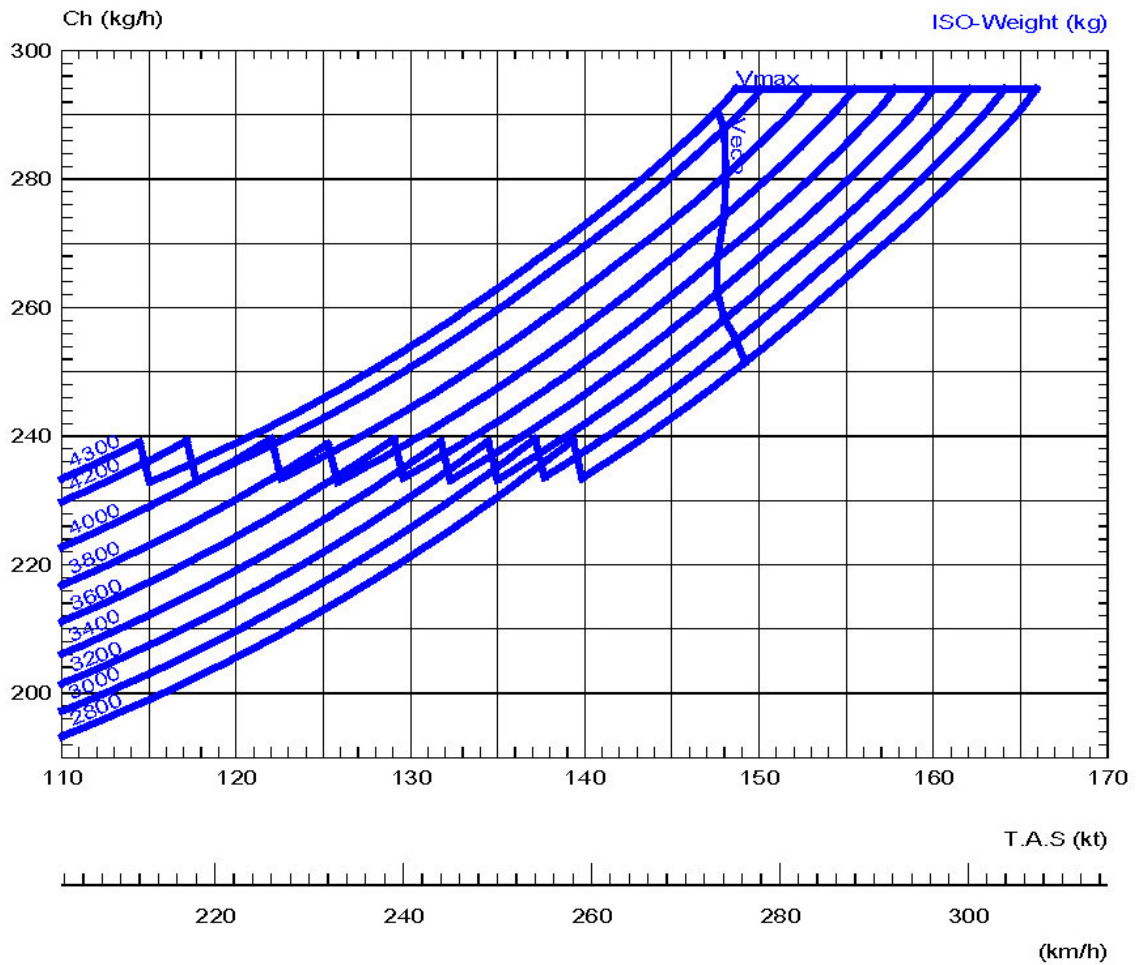

The data set forth in this document are general in nature and for information purposes only.

For performance data and operating limitations, reference must be made to the approved flight manual and all appropriate documents.

HOURLY FUEL CONSUMPTION IN LEVEL FLIGHT

Pressure-altitude = 10000 ft ; ISA (Temperature = -4.8 °C)

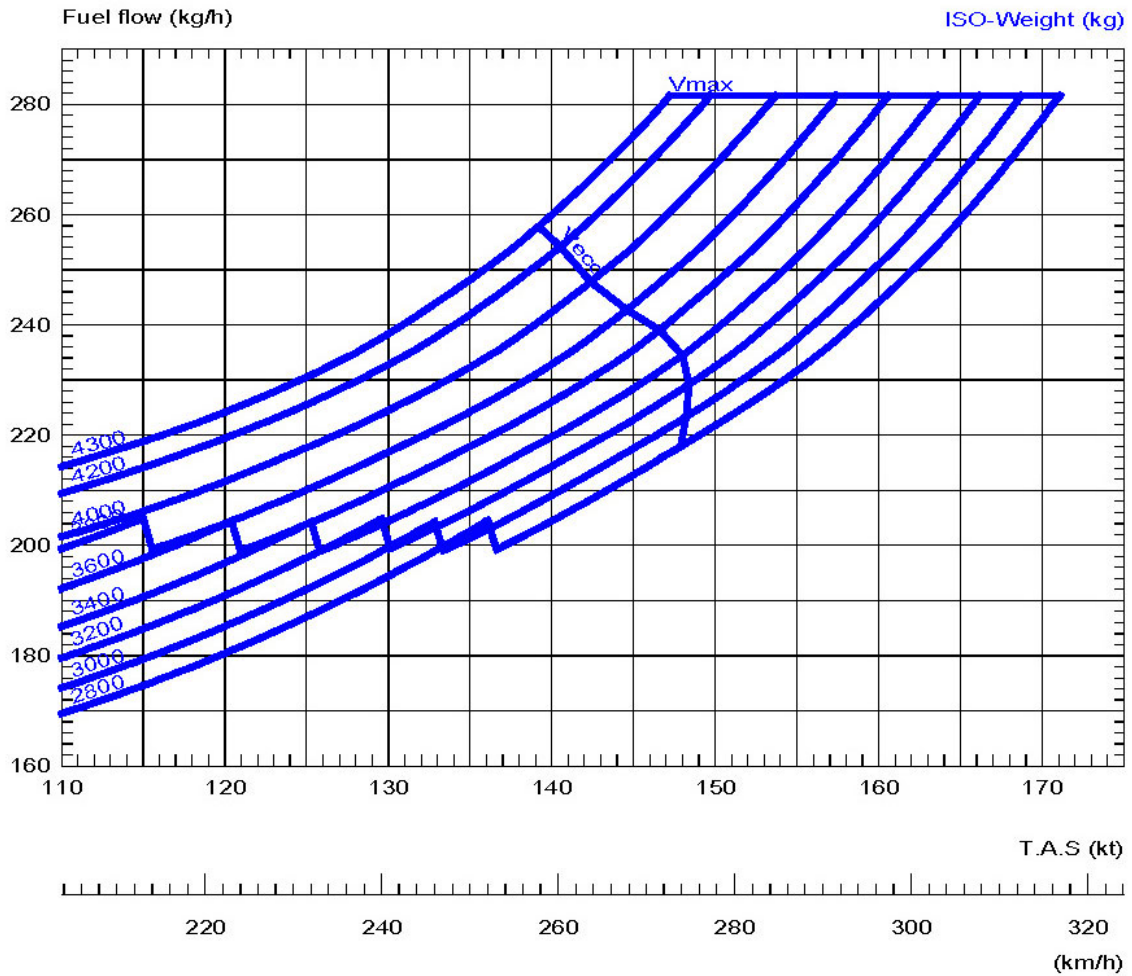

The data set forth in this document are general in nature and for information purposes only.

For performance data and operating limitations, reference must be made to the approved flight manual and all appropriate documents.

HOURLY FUEL CONSUMPTION IN LEVEL FLIGHT

Pressure-altitude = 0 ft ; ISA + 20 °C (Temperature = 35 °C)

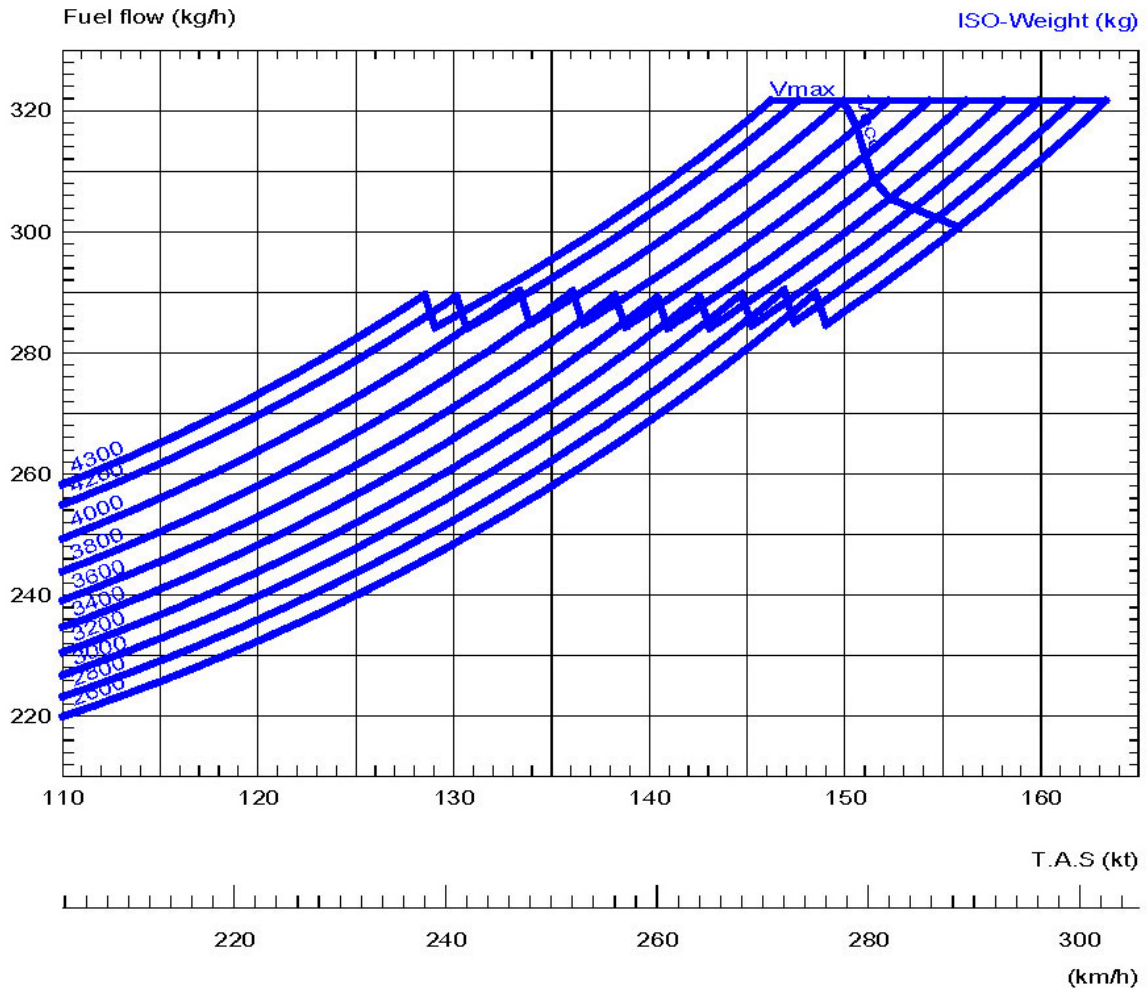

The data set forth in this document are general in nature and for information purposes only.

For performance data and operating limitations, reference must be made to the approved flight manual and all appropriate documents.

HOURLY FUEL CONSUMPTION IN LEVEL FLIGHT

Pressure-altitude = 5000 ft ; ISA+20 °C (Temperature = 25 °C)

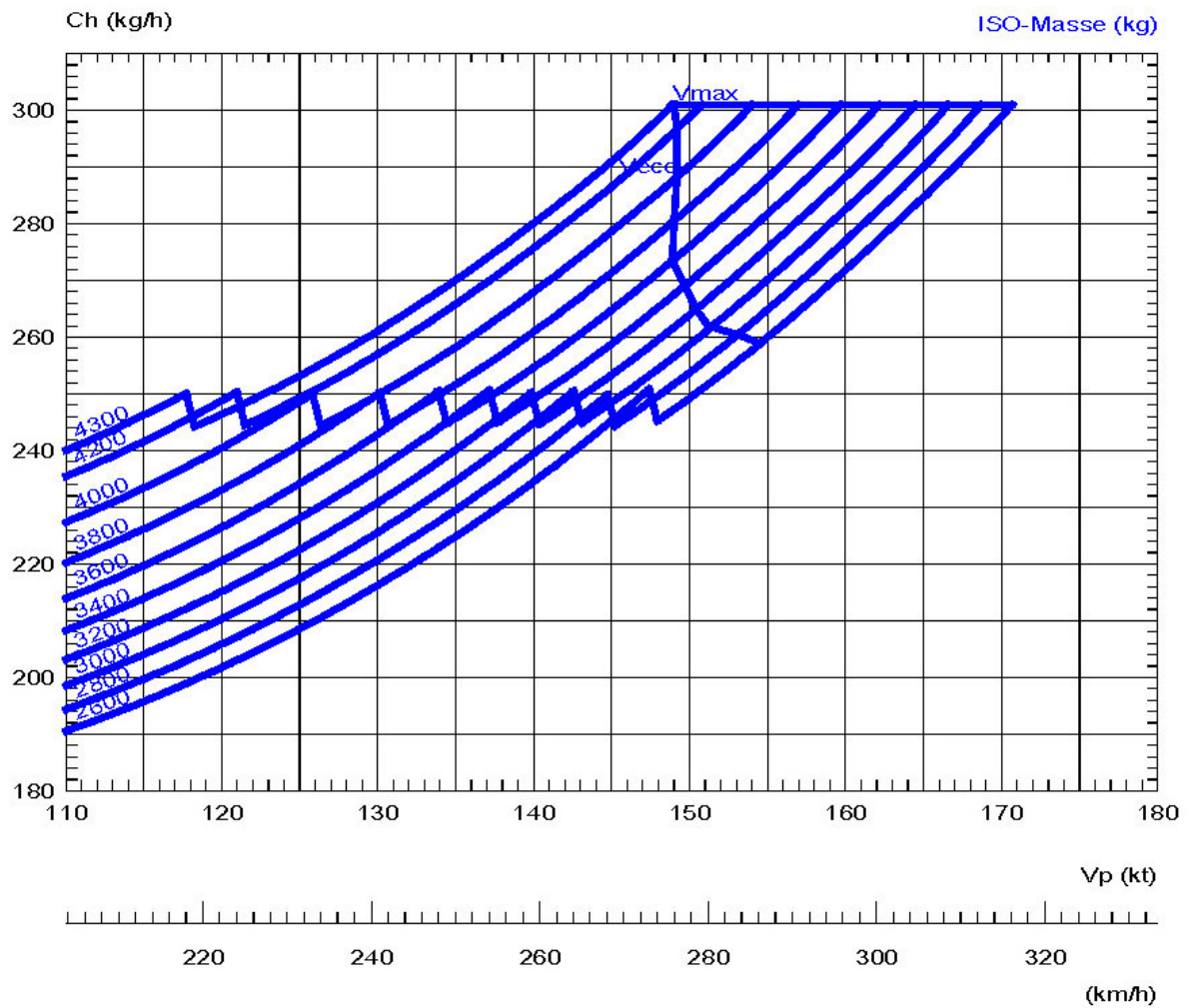

The data set forth in this document are general in nature and for information purposes only.

For performance data and operating limitations, reference must be made to the approved flight manual and all appropriate documents.

HOURLY FUEL CONSUMPTION IN LEVEL FLIGHT

Pressure-altitude = 10000 ft ;ISA + 20 °C (Temperature = 15.2 °C)

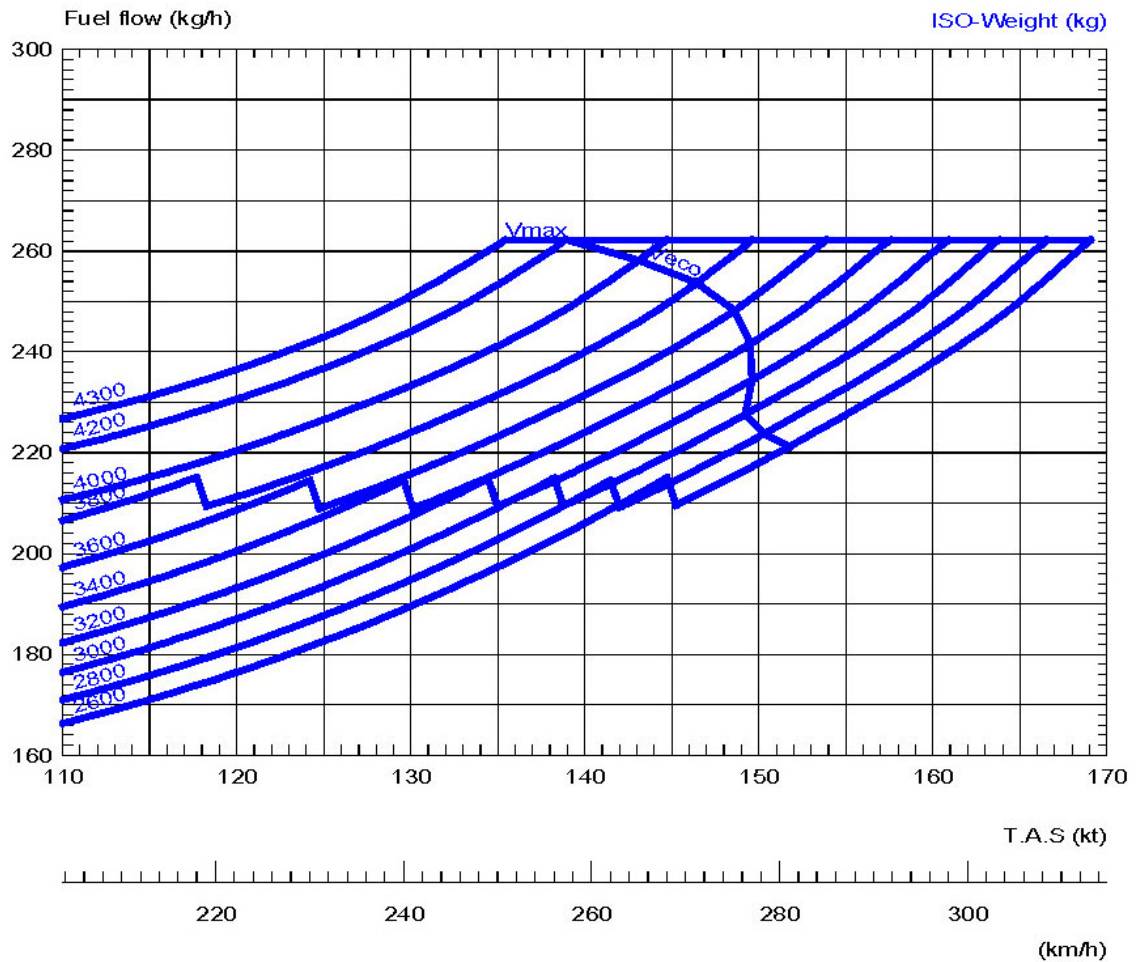

The data set forth in this document are general in nature and for information purposes only.

For performance data and operating limitations, reference must be made to the approved flight manual and all appropriate documents.

PAYLOAD / RANGE CHART

Pressure altitude = sea level; ISA

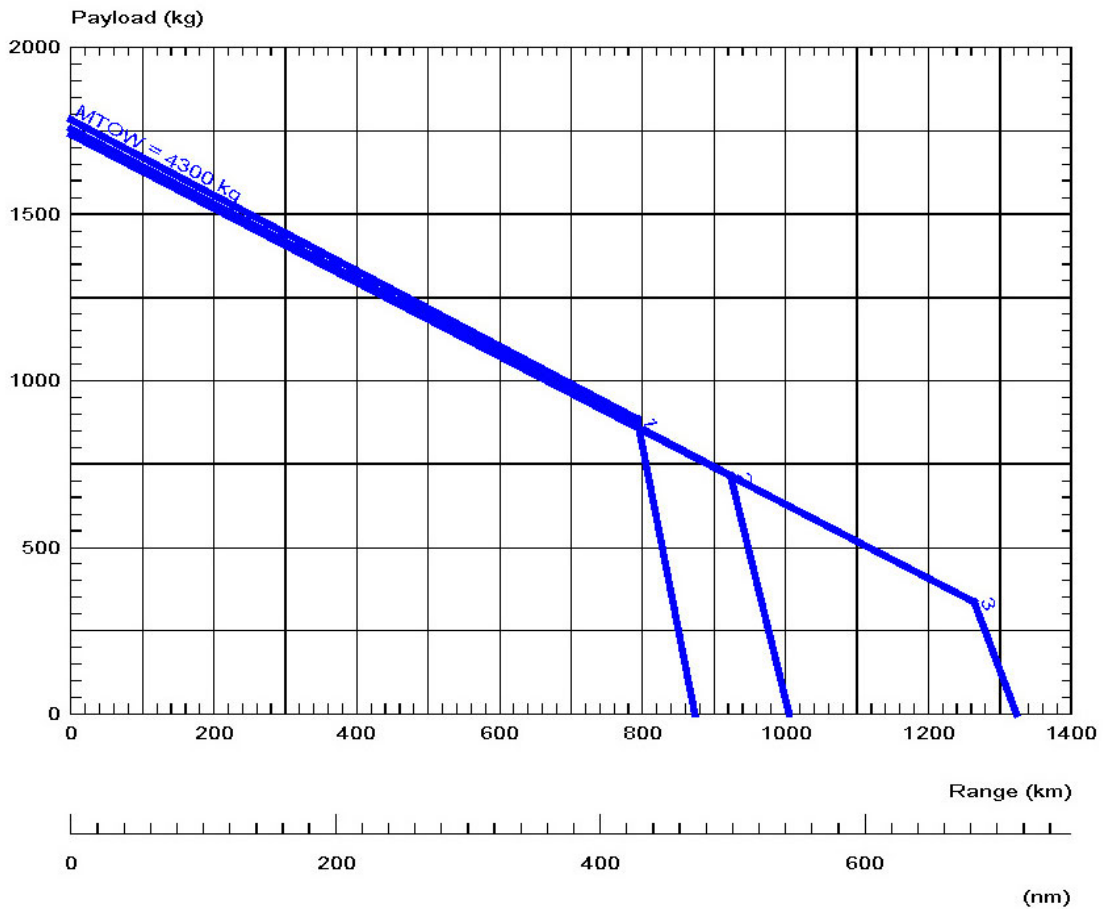

- Empty weight: 2,389 kg (1) / 2,416.6 kg (2), 2,421.9 kg (3)
- Pilot + copilot: 2 x 80 kg
- Fuel tanks:
 - 1. standard tanks: 897 kg
 - 2. standard tanks + auxiliary tank in the hold: 1039 kg
 - 3. standard tanks + auxiliary tank in the hold + ferrying tank in the cabin: 1402 kg

The data set forth in this document are general in nature and for information purposes only.

For performance data and operating limitations, reference must be made to the approved flight manual and all appropriate documents.

PAYLOAD / RANGE CHART

Pressure altitude = sea level; ISA + 20 °C

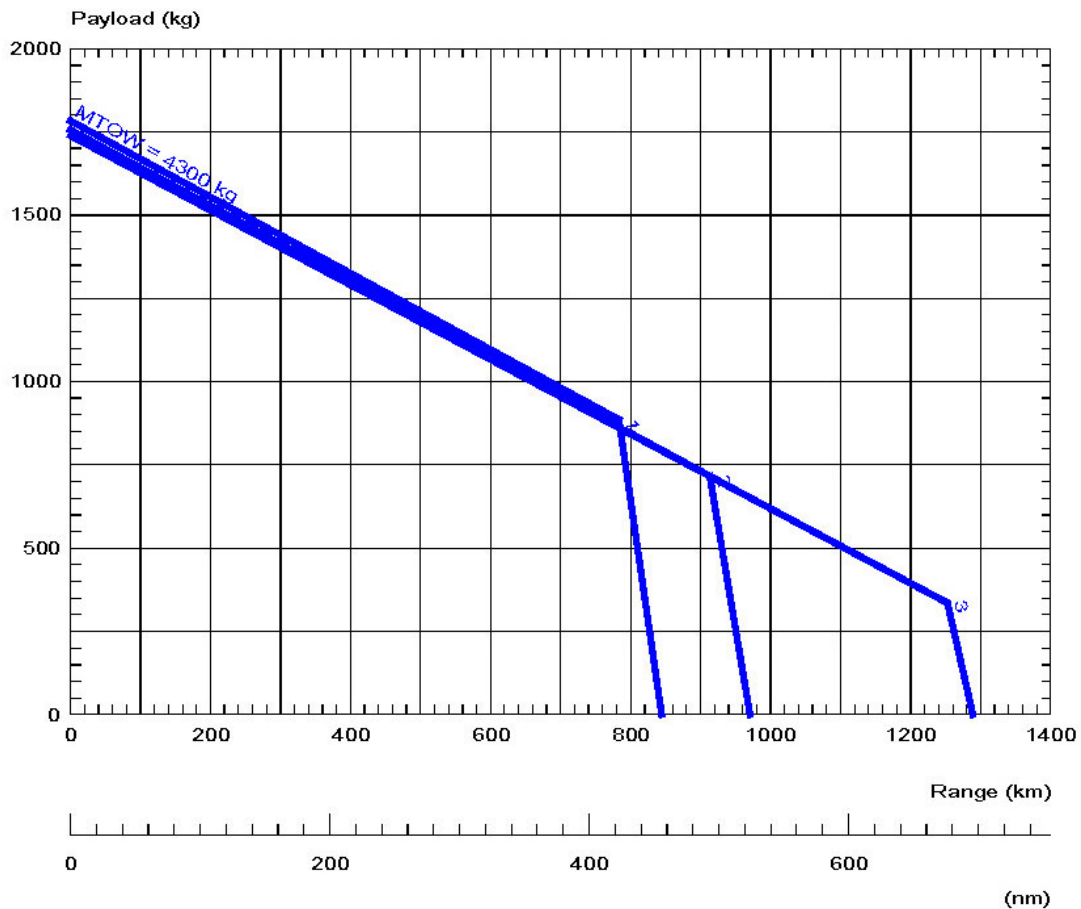

- Empty weight: 2,389 kg (1) / 2,416.6 kg (2), 2,421.9 kg (3)
- Pilot + copilot: 2 x 80 kg
- Fuel tanks:
 1. standard tanks: 897 kg
 2. standard tanks + auxiliary tank in the hold: 1039 kg
 3. standard tanks + auxiliary tank in the hold + ferrying tank in the cabin: 1402 kg

The data set forth in this document are general in nature and for information purposes only.

For performance data and operating limitations, reference must be made to the approved flight manual and all appropriate documents.

Blank

The data set forth in this document are general in nature and for information purposes only.

For performance data and operating limitations, reference must be made to the approved flight manual and all appropriate documents.

Blank



www.eurocopter.com

Eurocopter reserves the right to make configuration and data changes at any time without notice.
The facts and figures contained in this document and expressed in good faith do not constitute any offer or contract with Eurocopter