

CHAPTER 7. AIRCRAFT HARDWARE, CONTROL CABLES, AND TURNBUCKLES

SECTION 1. RIVETS

7-1. GENERAL.

a. **Standard solid-shank rivets** and the universal head rivets (AN470) are used in aircraft construction in both interior and exterior locations. All protruding head rivets may be replaced by MS20470 (supersedes AN470) rivets. This has been adopted as the standard for protruding head rivets in the United States.

b. **Roundhead rivets (AN430)** are used in the interior of aircraft except where clearance is required for adjacent members.

c. **Flathead rivets (AN442)** are used in the interior of the aircraft where interference of adjacent members does not permit the use of roundhead rivets.

d. **Brazierhead rivets (AN455 and AN456)** are used on the exterior surfaces of aircraft where flush riveting is not essential.

e. **Countersunk head rivets MS20426** (supersedes AN426 100-degree) are used on the exterior surfaces of aircraft to provide a smooth aerodynamic surface, and in other applications where a smooth finish is desired. The 100-degree countersunk head has been adopted as the standard in the United States. Refer to MIL-HD BK5 Metallic Materials and Elements for Flight Vehicle Structures, and U.S.A.F./Navy T./O. 1-1A-8, Structural Hardware.”

f. **Typical rivet types** are shown in table 7-10.

7-2. MATERIAL APPLICATIONS.

a. **Rivets made with 2117-T4** are the most commonly used rivets in aluminum alloy structures. The main advantage of 2117-T4 is that it may be used in the condition received without further treatment.

b. **The 2017-T3, 2017-T31, and 2024-T4** rivets are used in aluminum alloy structures where strength higher than that of the 2117-T4 rivet is needed. See Metallic Materials and Elements for Flight Vehicle Structures (MIL-HDBK-5) for differences between the types of rivets specified here.

c. **The 1100 rivets of pure aluminum** are used for riveting nonstructural parts fabricated from the softer aluminum alloys, such as 1100, 3003, and 5052.

d. **When riveting magnesium alloy structures**, 5056 rivets are used exclusively due to their corrosion-resistant qualities in combination with the magnesium alloys.

e. **Mild steel rivets** are used primarily in riveting steel parts. **Do not** use galvanized rivets on steel parts subjected to high heat.

f. **Corrosion-resistant steel rivets** are used primarily in riveting corrosion-resistant steel parts such as firewalls, exhaust stack bracket attachments, and similar structures.

g. Monel rivets are used in special cases for riveting high-nickel steel alloys and nickel alloys. They may be used interchangeably with stainless steel rivets as they are more easily driven. However, it is preferable to use stainless steel rivets in stainless steel parts.

h. Copper rivets are used for riveting copper alloys, leather, and other nonmetallic materials. This rivet has only limited usage in aircraft.

i. Hi-Shear rivets are sometimes used in connections where the shearing loads are the primary design consideration. Its use is restricted to such connections. It should be noted that Hi-Shear rivets are not to be used for the installation of control surface hinges and hinge brackets. Do not paint the rivets before assembly, even where dissimilar metals are being joined. However, it is advisable to touch up each end of the driven rivet with primer to allow the later application of the general airplane finish.

j. Blind rivets in the NASM20600 through NASM20603 series rivets and the mechanically-locked stem NAS 1398, 1399, 1738, and 1739 rivets sometimes may be substituted for solid rivets. They should not be used where the looseness or failure of a few rivets will impair the airworthiness of the aircraft. Design allowable for blind rivets are specified in MIL-HDBK-5. Specific structural applications are outlined in NASM33522. Nonstructural applications for such blind rivets as NASM20604 and NASM20605 are contained in NASM33557.

CAUTION: For sheet metal repairs to airframe, the use of blind rivets must be authorized by the airframe manufacturer or approved by a representative of the FAA.

For more information on blind rivets, see page 4-19, f. of this document.

7-3.—7-13. [RESERVED.]

SECTION 2. SCREWS

7-14. GENERAL. In general, screws differ from bolts by the following characteristics.

a. Screws usually have lower material strength, a looser thread fit, head shapes formed to engage a screwdriver, and the shank may be threaded along its entire length without a clearly defined grip. Screws may be divided into three basic groups: structural screws, machine screws, and self-tapping screws. Screws are marked as required by the applicable Army Navy (AN), National Aerospace Standard (NAS), or Military Standard (MS) drawing. Normally a manufacturer places his trademark on the head of the screw. Several types of structural screws are available that differ from the standard structural bolts only in the type of head.

b. It would be impossible to cover all screws that are available to the aviation market; therefore, only the most frequently used screws will be discussed in this text. Design specifications are available in MIL-HDBK-5, or U.S.A.F./Navy T.O.1-1A-8/NAVAIR 01-1A-8, Structural Hardware.

c. Typical screw types are shown in table 7-11.

7-15. STRUCTURAL SCREWS. NAS502, NAS503, AN509, NAS220 through NAS227, and NAS583 through NAS590, may be used for structural applications, similar to structural bolts or rivets. These screws are fabricated from a material with a high-tensile strength and differ from structural bolts only in the type of head.

7-16. MACHINE SCREWS. These screws are available in four basic head styles: flathead (countersunk), roundhead, fillister, and socket head.

a. Flathead machine screws (AN505, AN510, AN507, NAS200, NAS514, NAS517, and NAS662) are used in countersunk holes where a flush surface is desired.

b. Roundhead machine screws (AN515 and AN520) are general-purpose screws for use in nonstructural applications.

c. Fillister head machine screws (AN500 through AN503, AN116901 through AN116912, AN116913 through AN116924, AN116962 through AN116990, AN117002 through AN117030, and AN117042 through AN117070) are general-purpose screws that may be used as capscrews in light mechanical applications and are usually drilled for safety wire.

d. Socket head machine screws (NAS608 and NAS609) are designed to be driven into tapped holes by means of internal wrenches. They may be used in applications requiring high strength, compactness of assembled parts, or sinking of heads below surfaces into fitted holes.

7-17. PANHEAD SCREWS (NAS600 THROUGH NAS606, NAS610 THROUGH NAS616, NAS623, AND NAS1402 THROUGH NAS1406). Flathead screws (MS35188 through MS35203), panhead machine screws (MS35024 through MS35219), and truss-head screws (AN526) are general-purpose screws used where head height is not important.

7-18. SELF-TAPPING SCREWS. The self-tapping screw taps their own mating thread when driven into untapped or punched holes slightly smaller than the diameter of the screw. Self-tapping machine screws (AN504 and AN530), may be used to attach minor

nonstructural parts. Self-tapping sheet metal screws (AN504, AN530, AN531 and NAS548) may be used in blind applications for the temporary attachment of sheet metal for riveting and the permanent assembly of nonstructural assemblies. The MS21318 is a roundhead drive screw used in the attachment of nameplates or in sealing drain holes, and is not intended to be removed after installation. They are normally installed by driving the screw into a drilled hole with a hammer.

CAUTION: Self-tapping screws should never be used as a replacement for standard screws, nuts, bolts, or rivets in any aircraft structure.

7-19. WOOD SCREWS AN545 and AN550, MS35492 and MS35493 are screws used in wood structures of aircraft.

7-20,—7-33. [RESERVED.]

SECTION 3. BOLTS

7-34. GENERAL. “Hardware” is the term used to describe the various types of fasteners and small items used to assemble and repair aircraft structures and components. Only hardware with traceability to an approved manufacturing process or source should be used. This traceability will ensure that the hardware is at least equal to the original or properly-altered condition. Hardware that is not traceable or is improperly altered, may be substandard or counterfeit, since their physical properties cannot be substantiated. Selection and use of fasteners are as varied as the types of aircraft; therefore, care should be taken to ensure fasteners are approved by the Federal Aviation Administration (FAA) for the intended installation, repair, or replacement. Threaded fasteners (bolts/screws) and rivets are the most commonly used fasteners because they are designed to carry shear and/or tensile loads.

7-35. BOLTS. Most bolts used in aircraft structures are either general-purpose, internal-wrenching, or close-tolerance AN, NAS, or MS bolts. In certain cases, fastener manufacturers produce bolts of different dimensions or greater strength than the standard types. *Such bolts are made for a particular application, and it is of extreme importance to use like bolts in replacement.* Design specifications are available in MIL-HDBK-5 or USAF/Navy T.O. 1-1A-8/NAVAIR 01-1A-8. References should be made to military specifications and industry design standards such as NAS, the Society of Automotive Engineers (SAE), and Aerospace Material Standards (AMS). Typical bolt types are shown in table 7-12.

7-36. IDENTIFICATION. Aircraft bolts may be identified by code markings on the bolt heads. These markings generally denote the material of which the bolt is made, whether the

bolt is a standard AN-type or a special-purpose bolt, and sometimes include the manufacturer.

a. AN standard steel bolts are marked with either a raised dash or asterisk, corrosion-resistant steel is marked by a single dash, and AN aluminum-alloy bolts are marked with two raised dashes.

b. Special-purpose bolts include high-strength, low-strength, and close-tolerance types. These bolts are normally inspected by magnetic particle inspection methods. Typical markings include “SPEC” (usually heat-treated for strength and durability), and an aircraft manufacturer’s part number stamped on the head. Bolts with no markings are low strength. Close-tolerance NAS bolts are marked with either a raised or recessed triangle. The material markings for NAS bolts are the same as for AN bolts, except they may be either raised or recessed. Bolts requiring non-destructive inspection (NDI) by magnetic particle inspection are identified by means of colored lacquer, or head markings of a distinctive type. (See figure 7-1.)

7-37. GRIP LENGTH. In general, bolt grip lengths of a fastener is the thickness of the material the fastener is designed to hold when two or more parts are being assembled. Bolts of slightly greater grip length may be used, provided washers are placed under the nut or bolthead. The maximum combined height of washers that should be used is 1/8 inch. This limits the use of washers necessary to compensate for grip, up to the next standard grip size. Over the years, some fasteners specifications have been changed. For this reason, it is recommended when making repairs to an aircraft, whose original hardware is being replaced, that you must first measure the bolt before ordering, rather than relying on the parts manual for

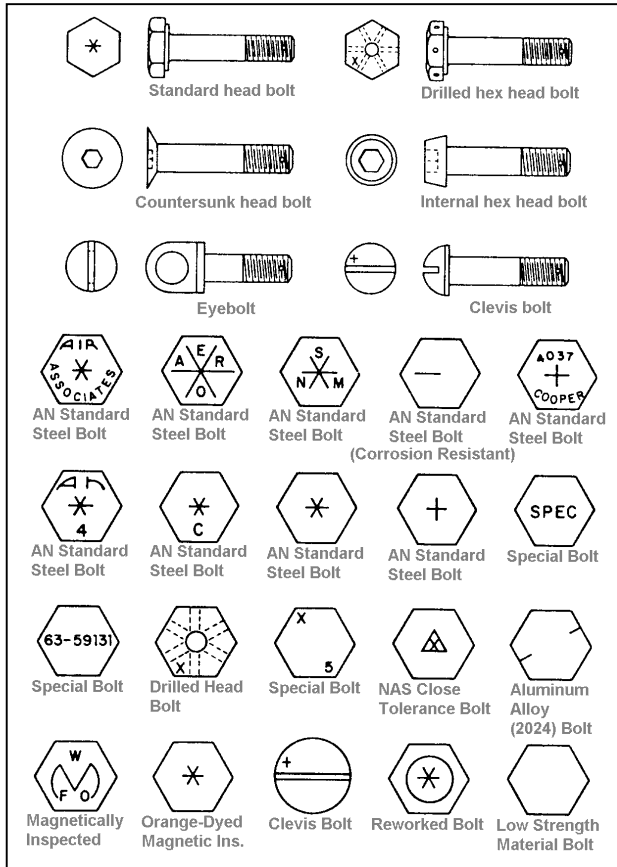

FIGURE 7-1. Typical aircraft bolt markings.

identification. In the case of plate nuts, if proper bolt grip length is not available, add shims under the plate. All bolt installations which involve self-locking or plain nuts should have at least one thread of the bolt protruding through the nut.

7-38. LOCKING OR SAFETYING OF BOLTS. Lock or safety all bolts and/or nuts, except self-locking nuts. Do not reuse cotter pins or safety wire.

7-39. BOLT FIT. Bolt holes, particularly those of primary connecting elements, have close tolerances. Generally, it is permissible to use the first-lettered drill size larger than the nominal bolt diameter, except when the AN hexagon bolts are used in light-drive fit (reamed) applications and where NAS close-tolerance bolts or AN clevis bolts are used. A light-drive fit can be defined as an interference

of 0.0006 inch for a 5/8 inch bolt. Bolt holes should be flush to the surface, and free of debris to provide full bearing surface for the bolt head and nut. In the event of over-sized or elongated holes in structural members, reaming or drilling the hole to accept the next larger bolt size may be permissible. Care should be taken to ensure items, such as edge distance, clearance, and structural integrity are maintained. Consult the manufacturer's structural repair manual, the manufacturer's engineering department, or the FAA before drilling or reaming any bolt hole in a critical structural member.

7-40. TORQUES. The importance of correct torque application cannot be overemphasized. Undertorque can result in unnecessary wear of nuts and bolts, as well as the parts they secure. Overtorque can cause failure of a bolt or nut from overstressing the threaded areas. Uneven or additional loads that are applied to the assembly may result in wear or premature failure. The following are a few simple, but important procedures, that should be followed to ensure that correct torque is applied.

NOTE: Be sure that the torque applied is for the size of the bolt shank not the wrench size.

a. **Calibrate the torque wrench** at least once a year, or immediately after it has been abused or dropped, to ensure continued accuracy.

b. **Be sure the bolt and nut threads are clean and dry**, unless otherwise specified by the manufacturer.

c. **Run the nut down to near contact** with the washer or bearing surface and check the friction drag torque required to turn the nut. Whenever possible, apply the torque to the nut and not the bolt. This will reduce rotation of the bolt in the hole and reduce wear.

d. Add the friction drag torque to the desired torque. This is referred to as “final torque,” which should register on the indicator or setting for a snap-over type torque wrench.

e. Apply a smooth even pull when applying torque pressure. If chattering or a jerking motion occurs during final torque, back off the nut and retorque.

NOTE: Many applications of bolts in aircraft/engines require stretch checks prior to reuse. This requirement is due primarily to bolt stretching caused by overtorquing.

f. When installing a castle nut, start alignment with the cotter pin hole at the minimum recommended torque plus friction drag torque.

NOTE: Do not exceed the maximum torque plus the friction drag. If the hole and nut castellation do not align, change washer or nut and try again. Exceeding the maximum recommended torque is not recommended.

g. When torque is applied to bolt heads or capscrews, apply the recommended torque plus friction drag torque.

h. If special adapters are used which will change the effective length of the torque wrench, the final torque indication or wrench setting must be adjusted accordingly. Determine the torque wrench indication or setting with adapter installed as shown in figure 7-2.

i. Table 7-1 shows the recommended torque to be used when specific torque is not supplied by the manufacturer. The table includes standard nut and bolt combinations, currently used in aviation maintenance. For further identification of hardware, see chapter 7, section 11.

7-41. STANDARD AIRCRAFT HEX HEAD BOLTS (AN3 THROUGH AN20). These are all-purpose structural bolts used for general applications that require tension or shear loads. Steel bolts smaller than No. 10-32, and aluminum alloy bolts smaller than 1/4 inch diameter, should not be used in primary structures. Do not use aluminum bolts or nuts in applications requiring frequent removal for inspection or maintenance.

7-42. DRILLED HEAD BOLTS (AN73 THROUGH AN81). The AN drilled head bolt is similar to the standard hex bolt, but has a deeper head which is drilled to receive safety wire. The physical differences preventing direct interchangeability are the slightly greater head height, and longer thread length of the AN73 through AN81 series. The AN73 through AN81 drilled head bolts have been superseded by MS20073, for fine thread bolts and MS20074 for coarse thread bolts. AN73, AN74, MS20073, and MS20074 bolts of like thread and grip lengths are universally, functionally, and dimensionally interchangeable.

7-43. ENGINE BOLTS. These are hex head bolts (AN101001 through AN101900), drilled shank hex head bolts (AN101901 through AN102800), drilled hex head (one hole) bolts (AN102801 through AN103700), and drilled hex head (six holes) bolts (AN103701 through AN104600). They are similar to each other except for the holes in the head and shank. Hex head bolts (AN104601 through AN105500), drilled shank hex head bolts (AN105501 through AN106400), drilled hex head (one hole) bolts (AN106401 through AN107300), and drilled hex head (six holes) bolts (AN107301 through AN108200) are similar to the bolts described in paragraph 7-42, except that this series is manufactured from corrosion-resistant steel.

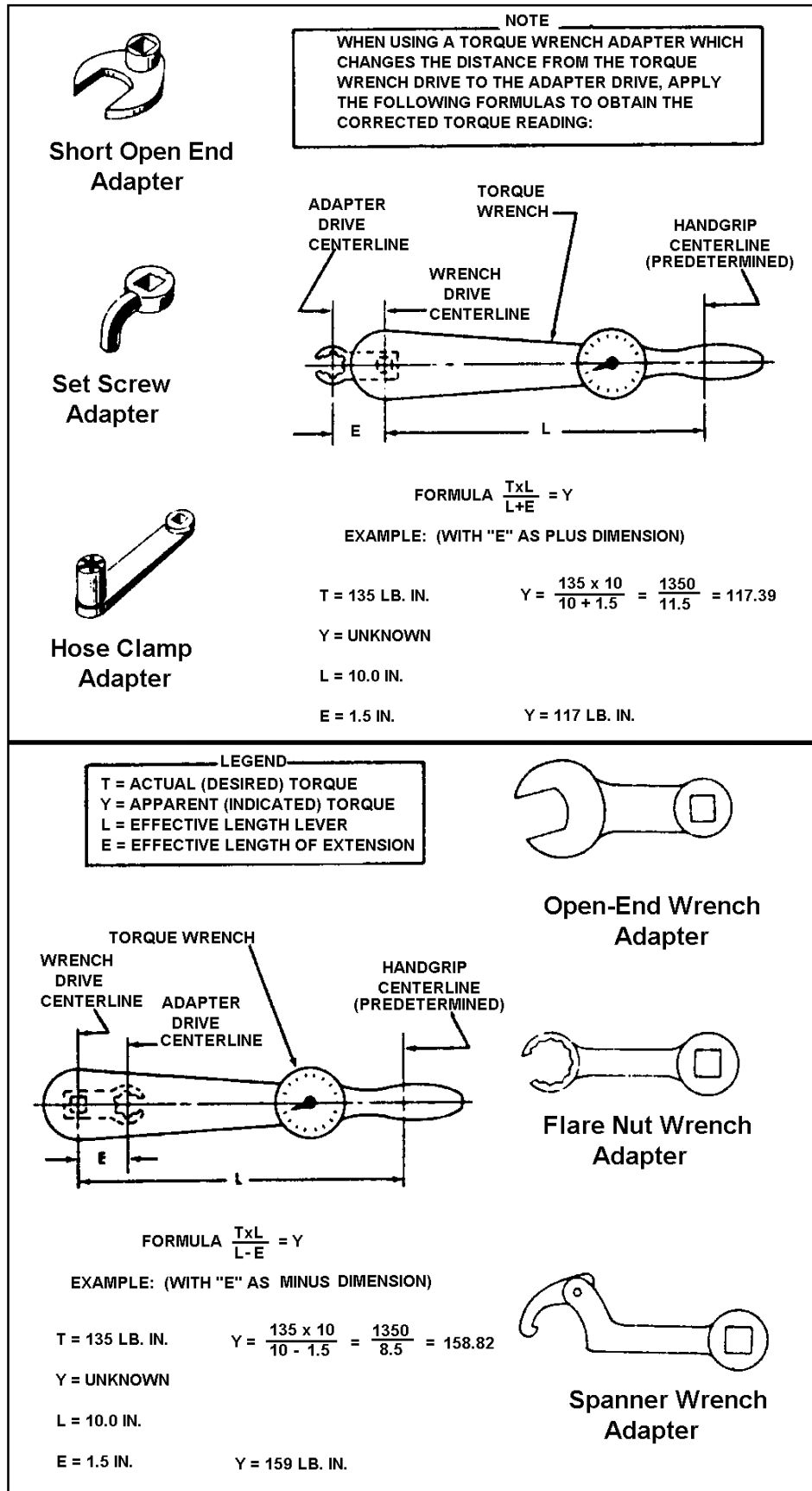

FIGURE 7-2. Torque wrench with various adapters.

TABLE 7-1. Recommended torque values (inch-pounds).

CAUTION THE FOLLOWING TORQUE VALUES ARE DERIVED FROM OIL FREE CADMIUM PLATED THREADS.				
		TORQUE LIMITS RECOMMENDED FOR INSTALLATION (BOLTS LOADED PRIMARILY IN SHEAR)		MAXIMUM ALLOWABLE TIGHTENING TORQUE LIMITS
Thread Size	Tension type nuts MS20365 and AN310 (40,000 psi in bolts)	Shear type nuts MS20364 and AN320 (24,000 psi in bolts)	Nuts MS20365 and AN310 (90,000 psi in bolts)	Nuts MS20364 and AN320 (54,000 psi in bolts)
FINE THREAD SERIES				
8-36	12-15	7-9	20	12
10-32	20-25	12-15	40	25
1/4-28	50-70	30-40	100	60
5/16-24	100-140	60-85	225	140
3/8-24	160-190	95-110	390	240
7/16-20	450-500	270-300	840	500
1/2-20	480-690	290-410	1100	660
9/16-18	800-1000	480-600	1600	960
5/8-18	1100-1300	600-780	2400	1400
3/4-16	2300-2500	1300-1500	5000	3000
7/8-14	2500-3000	1500-1800	7000	4200
1-14	3700-5500	2200-3300*	10,000	6000
1-1/8-12	5000-7000	3000-4200*	15,000	9000
1-1/4-12	9000-11,000	5400-6600*	25,000	15,000
COARSE THREAD SERIES				
8-32	12-15	7-9	20	12
10-24	20-25	12-15	35	21
1/4-20	40-50	25-30	75	45
5/16-18	80-90	48-55	160	100
3/8-16	160-185	95-100	275	170
7/16-14	235-255	140-155	475	280
1/2-13	400-480	240-290	880	520
9/16-12	500-700	300-420	1100	650
5/8-11	700-900	420-540	1500	900
3/4-10	1150-1600	700-950	2500	1500
7/8-9	2200-3000	1300-1800	4600	2700
The above torque values may be used for all cadmium-plated steel nuts of the fine or coarse thread series which have approximately equal number of threads and equal face bearing areas. * Estimated corresponding values.				

7-44. CLOSE-TOLERANCE BOLTS.

Close-tolerance, hex head, machine bolts (AN173 through AN186), 100-degree countersunk head, close-tolerance, high-strength bolts (NAS333 through NAS340), hex head, close-tolerance, short thread, titanium alloy bolts (NAS653 through NAS658), 100-degree countersunk flathead, close-tolerance titanium alloy bolts (NAS663 through NAS668), and drilled hex head close-tolerance titanium alloy bolts (NAS673 through NAS678), are used in applications where two parts bolted together are subject to severe load reversals and vibration. Because of the interference fit, this type

of bolt may require light tapping with a mallet to set the bolt shank into the bolt hole.

NOTE: Elimination of friction in interference fit applications may sometimes be attained by placing the bolt in a freezer prior to installation. When this procedure is used, the bolt should be allowed to warm up to ambient temperature before torquing.

CAUTION: Caution must be exercised in the use of close-tolerance bolts for all critical applications, such as

landing gear, control systems, and helicopter rotary controls. Do not substitute for close-tolerance fasteners without specific instructions from the aircraft manufacturer or the FAA.

7-45. INTERNAL WRENCHING BOLTS (NAS144 THROUGH NAS158 AND NAS172 THROUGH NAS176). These are high-strength bolts used primarily in tension applications. Use a special heat-treated washer (NAS143C) under the head to prevent the large radius of the shank from contacting only the sharp edge of the hole. Use a special heat-treated washer (NAS143) under the nut.

7-46. INTERNAL WRENCHING BOLTS (MS20004 THROUGH MS20024) AND SIX HOLE, DRILLED SOCKET HEAD BOLTS (AN148551 THROUGH AN149350). These are very similar to the bolts in paragraph 7-45, except these bolts are made from different alloys. The NAS144 through NAS158 and NAS172 through NAS176 are interchangeable with MS20004 through MS20024 in the same thread configuration and grip lengths. The AN148551 through AN149350 have been superseded by MS9088 through MS9094 with the exception of AN149251 through 149350, which has no superseding MS standard.

7-47. TWELVE POINT, EXTERNAL WRENCHING BOLTS, (NAS624 THROUGH NAS644). These bolts are used primarily in high-tensile, high-fatigue strength applications. The twelve point head, heat-resistant machine bolts (MS9033 through

MS9039), and drilled twelve point head machine bolts (MS9088 through MS9094), are similar to the (NAS624 through NAS644); but are made from different steel alloys, and their shanks have larger tolerances.

7-48. CLOSE-TOLERANCE SHEAR BOLTS (NAS464). These bolts are designed for use where stresses normally are in shear only. These bolts have a shorter thread than bolts designed for torquing.

7-49. NAS6200 SERIES BOLTS. These are close tolerance bolts and are available in two oversized diameters to fit slightly elongated holes. These bolts can be ordered with an "X" or "Y" after the length, to designate the oversized grip portion of the bolt (i.e., NAS6204-6X for a 1/4 inch bolt with a 1/64 inch larger diameter). The elongated hole may have to be reamed to insure a good fit.

7-50. CLEVIS BOLTS (AN21 THROUGH AN36). These bolts are only used in applications subject to shear stress, and are often used as mechanical pins in control systems.

7-51. EYEBOLTS (AN42 THROUGH AN49). These bolts are used in applications where external tension loads are to be applied. The head of this bolt is specially designed for the attachment of a turnbuckle, a clevis, or a cable shackle. The threaded shank may or may not be drilled for safetying.

7-52.—7-62. [RESERVED.]

SECTION 4. NUTS

7-63. GENERAL. Aircraft nuts are available in a variety of shapes, sizes, and material strengths. The types of nuts used in aircraft structures include castle nuts, shear nuts, plain nuts, light hex nuts, checknuts, wingnuts, and sheet spring nuts. Many are available in either self-locking or nonself-locking style. Typical nut types are shown in table 7-13. Refer to the aircraft manufacturer's structural repair manual, the manufacturer's engineering department, or the FAA, before replacing any nut with any other type.

7-64. SELF-LOCKING NUTS. These nuts are acceptable for use on certificated aircraft subject to the aircraft manufacturer's recommended practice sheets or specifications. Two types of self-locking nuts are currently in use, the all-metal type, and the fiber or nylon type.

a. DO NOT use self-locking nuts on parts subject to rotation.

b. Self-locking castellated nuts with cotter pins or lockwire may be used in any system.

c. Self-locking nuts should not be used with bolts or screws on turbine engine airplanes in locations where the loose nut, bolt, washer, or screw could fall or be drawn into the engine air intake scoop.

d. Self-locking nuts should not be used with bolts, screws, or studs to attach access panels or doors, or to assemble any parts that are routinely disassembled before, or after each flight. They may be used with anti-friction bearings and control pulleys, provided the inner race of the bearing is secured to the supporting structure by the nut and bolt.

e. Metal locknuts are constructed with either the threads in the locking insert, out-of-round with the load-carrying section, or with a saw-cut insert with a pinched-in thread in the locking section. The locking action of the all-metal nut depends upon the resiliency of the metal when the locking section and load-carrying section are engaged by screw threads. Metal locknuts are primarily used in high temperature areas.

f. Fiber or nylon locknuts are constructed with an unthreaded fiber or nylon locking insert held securely in place. The fiber or nylon insert provides the locking action because it has a smaller diameter than the nut. Fiber or nylon self-locking nuts are not installed in areas where temperatures exceed 250 °F. After the nut has been tightened, make sure the bolt or stud has at least one thread showing past the nut. **DO NOT** reuse a fiber or nylon locknut, if the nut cannot meet the minimum prevailing torque values. (See table 7-2.)

g. Self-locking nut plates are produced in a variety of forms and materials for riveting or welding to aircraft structures or parts. Certain applications require the installation of self-locking nuts in channel arrangement permitting the attachment of many nuts in a row with only a few rivets.

7-65. NUT IDENTIFICATION FINISHES. Several types of finishes are used on self-locking nuts. The particular type of finish is dependent on the application and temperature requirement. The most commonly used finishes are described briefly as follows.

TABLE 7-2. Minimum prevailing torque values for re-used self-locking nuts.

FINE THREAD SERIES	
THREAD SIZE	MINIMUM PREVAILING TORQUE
7/16 - 20	8 inch-pounds
1/2 - 20	10 inch-pounds
9/16 - 18	13 inch-pounds
5/8 - 18	18 inch-pounds
3/4 - 16	27 inch-pounds
7/8 - 14	40 inch-pounds
1 - 14	55 inch-pounds
1-1/8 - 12	73 inch-pounds
1-1/4 - 12	94 inch-pounds
COARSE THREAD SERIES	
THREAD SIZE	MINIMUM PREVAILING TORQUE
7/16 - 14	8 inch-pounds
1/2 - 13	10 inch-pounds
9/16 - 12	14 inch-pounds
5/8 - 11	20 inch-pounds
3/4 - 10	27 inch-pounds
7/8 - 9	40 inch-pounds
1 - 8	51 inch-pounds
1-1/8 - 8	68 inch-pounds
1-1/4 - 8	88 inch-pounds

a. Cadmium-Plating. This is an electrolytically deposited silver-gray plating which provides exceptionally good protection against corrosion, particularly in salty atmosphere, but is not recommended in applications where the temperature exceeds 450 °F. The following additional finishes or refinements to the basic cadmium can be applied.

(1) Chromic Clear Dip. Cadmium surfaces are passivated, and cyanide from the plating solution is neutralized. The protective film formed gives a bright, shiny appearance, and resists staining and finger marks.

(2) Olive Drab Dichromate. Cadmium-plated work is dipped in a solution of chromic acid, nitric acid, acetic acid, and a dye which produces corrosion resistance.

(3) Iridescent Dichromate. Cadmium-plated work is dipped in a solution of sodium dichromate and takes on a surface film of basic chromium chromate which resists corrosion. Finish is yellow to brown in color.

NOTE: Cadmium-plated nuts are restricted for use in temperatures not to exceed 450 °F. When used in temperatures in excess of 450 °F, the cadmium will diffuse into the base material causing it to become very brittle and subject to early failure.

b. Silver plating. Silver plating is applied to locknuts for use at higher temperatures. Important advantages are its resistance to extreme heat (1,400 °F) and its excellent lubricating characteristics. Silver resists galling and seizing of mating parts when subjected to heat or heavy pressure.

c. Anodizing for Aluminum. An inorganic oxide coating is formed on the metal by connecting the metals and anodes in a suitable electrolyte. The coating offers excellent corrosion resistance and can be dyed in a number of colors.

d. Solid Lubricant Coating. Locknuts are also furnished with molybdenum disulfide for lubrication purposes. It provides a clean, dry, permanently-bonded coating to prevent seizing and galling of threads. Molybdenum disulfide is applied to both cadmium and silver-plated parts. Other types of finishes are available, but the finishes described in this chapter are the most widely used.

7-66. CASTLE NUT (AN310). The castle nut is used with drilled shank hex head bolts, clevis bolts, drilled head bolts, or studs that are subjected to tension loads. The nut has slots or castellations cut to accommodate a cotter pin or safety wire as a means of safetying.

7-67. CASTELLATED SHEAR NUT (AN320). The castellated shear nut is designed for use with hardware subjected to shear stress only.

7-68. PLAIN NUT (AN315 AND AN335). The plain nut is capable of withstanding large tension loads; however, it requires an auxiliary locking device, such as a checknut or safety wire. Use of this type on aircraft structures is limited.

7-69. LIGHT HEX NUTS (AN340 AND AN345). These nuts are used in nonstructural applications requiring light tension. Like the AN315 and AN335, they require a locking device to secure them.

7-70. CHECKNUT (AN316). The checknut is used as a locking device for plain nuts, screws, threaded rod ends, and other devices.

7-71. WINGNUTS (AN350). The wingnut is used where the desired torque is obtained by use of the fingers or handtools. Wingnuts are normally drilled to allow safetying with safety wire.

7-72. SHEET SPRING NUTS (AN365). Sheet spring nuts are commonly called speed nuts. They are used with standard and sheet metal self-tapping screws in nonstructural applications. They are used to support line and conduit clamps, access doors, etc. Their use should be limited to applications where they were originally used in assembly of the aircraft.

7-73.—7-84. RESERVED.

SECTION 5. WASHERS

7-85. GENERAL. The type of washers used in aircraft structure are plain washers, , and special washers. Typical washer types are shown in table 7-14.

7-86. PLAIN WASHERS (AN960 AND AN970). Plain washers are widely used with hex nuts to provide a smooth bearing surface, act as a shim to obtain the proper grip length, and to position castellated nuts in relation to drilled cotter pin holes in bolts. Use plain washers under lock washers to prevent damage to bearing surfaces. Cadmium-plated steel washers are recommended for use under boltheads and nuts used on aluminum alloy or magnesium structures to prevent corrosion. The AN970 steel washer provides a larger bearing surface than the plain type, and is often used in wooden structures under boltheads and nuts to prevent local crushing of the surface.

7-87. LOCKWASHERS (AN935 AND AN936). Lock washers may be used with machine screws or bolts whenever the self-locking or castellated type nut is not applicable. Do not use lock washers where frequent removal is required, in areas subject to corrosion, or in areas exposed to airflow. Use a plain washer between the lock washer and material to prevent gouging the surface of the metal.

CAUTION: Lock washers are not to be used on primary structures, secondary structures, or accessories where failure might result in damage or danger to aircraft or personnel.

7-88. BALL SOCKET AND SEAT WASHERS (AN950 AND AN955). Ball socket and seat washers are used in special applications where the bolt is installed at an angle to the surface or when perfect alignment with the surface is required. These washers are used together as a pair.

7-89. TAPER PIN WASHERS (AN975). Taper pin washers are used with the threaded taper pin. NAS143 and MS20002 washers are used with NAS internal wrenching bolts and internal wrenching nuts. They may be plain or countersunk. The countersunk washer (designated as NAS143C and MS20002C) is used to seat the bolthead shank radius, and the plain washer is used under the nut.

7-90.—7-100. [RESERVED.]

SECTION 6. PINS

7-101. TAPER PINS. Plain (AN385) and threaded (AN386) taper pins are used in joints which carry shear loads and where the absence of play is essential. The plain taper pin is usually drilled and secured with wire. The threaded taper pin is used with a taper-pin washer (AN975) and shear nut (safetied with a cotter pin) or self-locking nut (if undrilled). Typical pin types are shown in table 7-15.

7-102. FLATHEAD PINS (AN392 THROUGH AN406). Commonly called a clevis pin, this pin is used in conjunction with tie-rod terminals and in secondary controls which are not subject to continuous operation. The pin is normally installed with the head up, or forward, to prevent loss should the cotter pin fail or work out.

7-103. COTTER PINS (AN380). Cotter pins are used for securing bolts, screws, nuts, and pins. Use AN381 or MS24665 cotter pins in locations where nonmagnetic material or resistance to corrosion is desired. Cotter pins should not be reused.

7-104. SPRING PINS. The spring pin is designed for use in double-shear applications. The pins are manufactured with the diameter greater than the holes in which they are to be used. Spring pins are stronger than mild carbon steel straight pins, taper pins, or grooved pins of the equivalent size. The spring pin is compressed as it is driven into the hole, and exerts continuous spring pressure against the sides of the hole to prevent loosening by vibration. Spring pins require no other means of securing, and can be used inside one another to increase shear strength.

a. Be careful when using these pins, since spring-pin performance depends entirely on the fit and the durability of the fit under

vibration or repeated load conditions (especially in soft materials, such as aluminum alloys and magnesium). They should not be used in an aircraft component or system where the loss or failure of the pin might endanger safe flight.

b. The joints where spring pins are used for fastening shall be designed like riveted and bolted joints. Spring pins should not be mixed with other structural fasteners in the same joint. These pins, for primary structural applications, should be used only where there will be no rotation or relative movement of the joint. Spring pins may be reused if a careful inspection reveals no deformation of the pin or hole.

c. Be careful to observe that the hole has not enlarged or deformed preventing proper functioning of the spring pin. Where hole misalignment results in the pin gap closing or necessitates excess inserting force, the spring pin will not be used. The spring pin should not be used as a substitute for a cotter pin. When a spring pin is used in a clevis joint, it is recommended that the pin be held by the outer members of the unit for maximum efficiency and reduced maintenance.

7-105. QUICK-RELEASE PINS. These pins are used in some applications where rapid removal and replacement of equipment is necessary. When equipment is secured with these pins, no binding of the spindle should be present. Spindle binding could cause the locking balls to remain in the open position which could result in the pin falling out under vibration.

7-106—7-121. [RESERVED.]

SECTION 7. SAFETYING

7-122. GENERAL. The word *safetying* is a term universally used in the aircraft industry. Briefly, safetying is defined as: "Securing by various means any nut, bolt, turnbuckle etc., on the aircraft so that vibration will not cause it to loosen during operation." These practices are not a means of obtaining or maintaining torque, rather a safety device to prevent the disengagement of screws, nuts, bolts, snap rings, oil caps, drain cocks, valves, and parts. Three basic methods are used in safetying; safety-wire, cotter pins, and self-locking nuts. Retainer washers and pal nuts are also sometimes used.

a. Wire, either soft brass or steel is used on cylinder studs, control cable turnbuckles, and engine accessory attaching bolts.

b. Cotter pins are used on aircraft and engine controls, landing gear, and tailwheel assemblies, or any other point where a turning or actuating movement takes place.

c. Self-locking nuts are used in applications where they will not be removed often. Repeated removal and installation will cause the self-locking nut to lose its locking feature. They should be replaced when they are no longer capable of maintaining the minimum prevailing torque. (See table 7-2.)

d. Pal or speed nuts include designs which force the nut thread against the bolt or screw thread when tightened. These nuts should never be reused and should be replaced with new ones when removed.

7-123. SAFETY WIRE. Do not use stainless steel, monel, carbon steel, or aluminum alloy safety wire to secure emergency mechanisms such as switch handles, guards covering handles used on exits, fire extinguishers,

emergency gear releases, or other emergency equipment. Some existing structural equipment or safety-of-flight emergency devices require copper or brass safety wire (.020 inch diameter only). Where successful emergency operation of this equipment is dependent on shearing or breaking of the safety wire, particular care should be used to ensure that safetying does not prevent emergency operation.

a. There are two methods of safety wiring; the double-twist method that is most commonly used, and the single-wire method used on screws, bolts, and/or nuts in a closely-spaced or closed-geometrical pattern such as a triangle, square, rectangle, or circle. The single-wire method may also be used on parts in electrical systems and in places that are difficult to reach. (See figures 7-3 and 7-3a.)

b. When using double-twist method of safety wiring, .032 inch minimum diameter wire should be used on parts that have a hole diameter larger than .045 inch. Safety wire of .020 inch diameter (double strand) may be used on parts having a nominal hole diameter between .045 and .062 inch with a spacing between parts of less than 2 inches. When using the single-wire method, the largest size wire that the hole will accommodate should be used. Copper wire (.020 inch diameter), aluminum wire (.031 inch diameter), or other similar wire called for in specific technical orders, should be used as seals on equipment such as first-aid kits, portable fire extinguishers, emergency valves, or oxygen regulators.

CAUTION: Care should be taken not to confuse steel with aluminum wire.

c. A secure seal indicates that the component has not been opened. Some emergency devices require installation of brass or soft

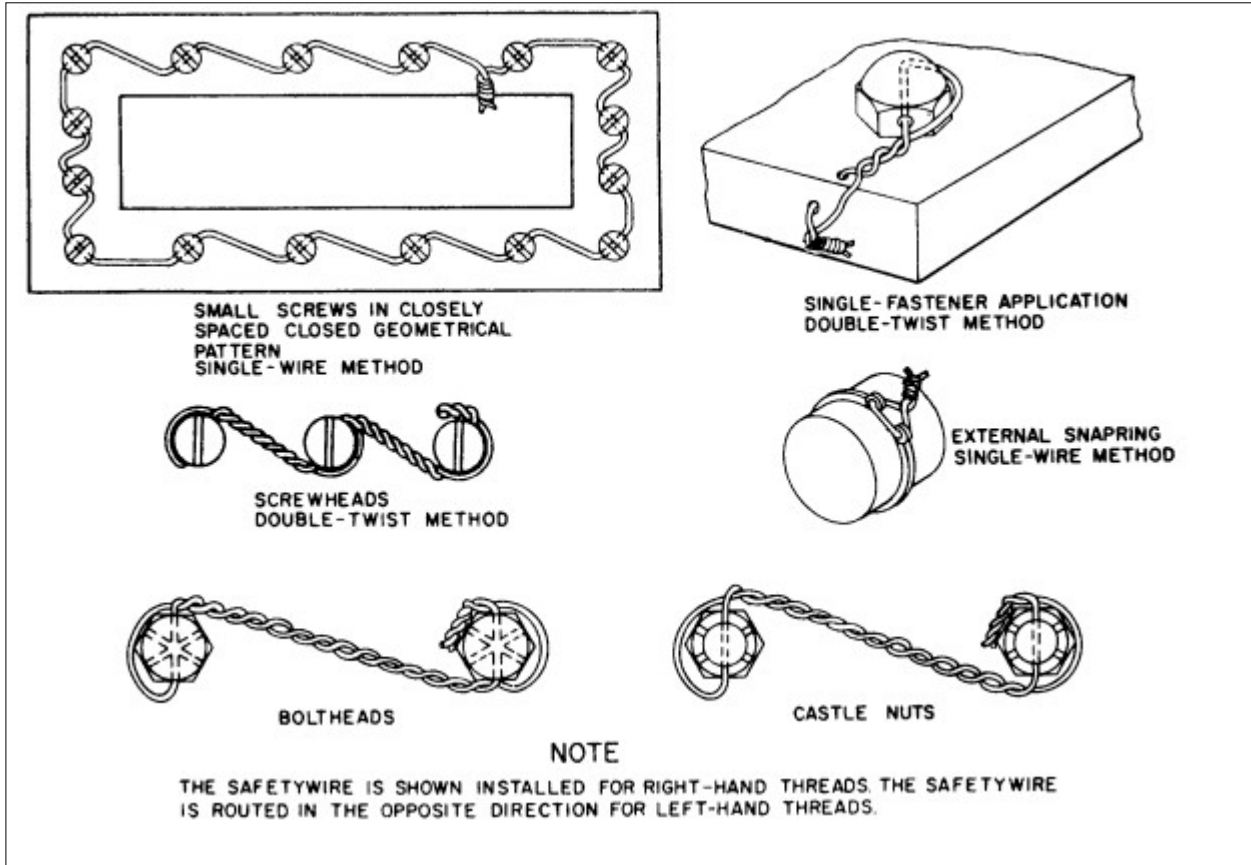

FIGURE 7-3. Securing screws, nuts, bolts, and snaprings.

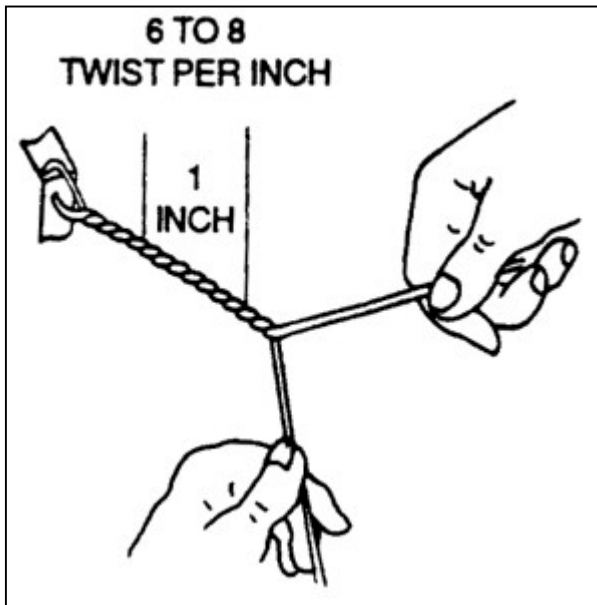

FIGURE 7-3a. Wire twisting by hand.

copper shear safety wire. Particular care should be exercised to ensure that the use of safety wire will not prevent emergency operation of the devices.

7-124. SAFETY-WIRING PROCEDURES.

There are many combinations of safety wiring with certain basic rules common to all applications. These rules are as follows.

a. When bolts, screws, or other parts are closely grouped, it is more convenient to safety wire them in series. The number of bolts, nuts, screws, etc., that may be wired together depends on the application.

b. Drilled boltheads and screws need not be safety wired if installed with self-locking nuts.

c. To prevent failure due to rubbing or vibration, safety wire must be tight after installation.

d. Safety wire must be installed in a manner that will prevent the tendency of the part to loosen.

e. Safety wire must never be overstressed. Safety wire will break under vibrations if twisted too tightly. Safety wire must be pulled taut when being twisted, and maintain a light tension when secured. (See figure 7-3a.)

f. Safety-wire ends must be bent under and inward toward the part to avoid sharp or projecting ends, which might present a safety hazard.

g. Safety wire inside a duct or tube must not cross over or obstruct a flow passage when an alternate routing can be used.

(1) Check the units to be safety wired to make sure that they have been correctly torqued, and that the wiring holes are properly aligned to each other. When there are two or more units, it is desirable that the holes in the units be aligned to each other. Never overtorque or loosen to obtain proper alignment of the holes. It should be possible to align the wiring holes when the bolts are torqued within the specified limits. Washers may be used (see paragraph 7-37) to establish proper alignment. However, if it is impossible to obtain a proper alignment of the holes without undertorquing or overtorquing, try another bolt which will permit proper alignment within the specified torque limits.

(2) To prevent mutilation of the twisted section of wire, when using pliers, grasp the wires at the ends. Safety wire must not be nicked, kinked, or mutilated. Never twist the wire ends off with pliers; and, when cutting off

ends, leave at least four to six complete turns (1/2 to 5/8 inch long) after the loop. When removing safety wire, never twist the wire off with pliers. Cut the safety wire close to the hole, exercising caution.

h. Install safety wire where practicable with the wire positioned around the head of the bolt, screw, or nut, and twisted in such a manner that the loop of the wire fits closely to the contour of the unit being safety wired.

7-125. TWISTING WITH SPECIAL TOOLS. Twist the wire with a wire twister as follows. (See figure 7-4.)

CAUTION: When using wire twist-ers, and the wire extends 3 inches beyond the jaws of the twist-ers, loosely wrap the wire around the pliers to prevent whipping and possible personal injury. Excessive twisting of the wire will weaken the wire.

a. Grip the wire in the jaws of the wire twister and slide the outer sleeve down with your thumb to lock the handles or lock the spring-loaded pin.

b. Pull the knob, and the spiral rod spins and twists the wire.

c. Squeeze handles together to release wire.

7-126. SECURING OIL CAPS, DRAIN COCKS, AND VALVES. (See figure 7-4a.) When securing oil caps and drain cocks, the safety wire should be anchored to an adjacent fillister-head screw. This method of safety wiring is applied to wingnuts, filler plugs, single-drilled head bolts, fillister-head screws, etc.; which are safety wired individually. When securing valve handles in the vertical position, the wire is looped around the threads of the pipe leading into one side of the valve,

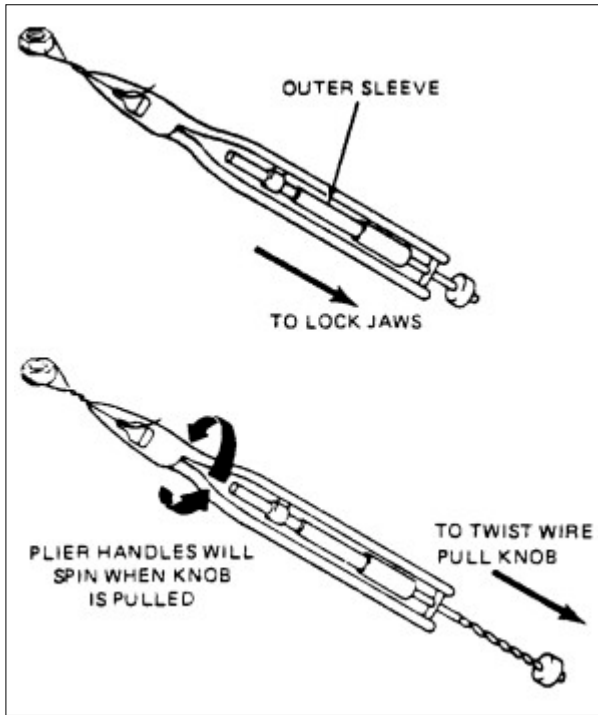

FIGURE 7-4. Use of a typical wire twister.

double-twisted around the valve handle, and anchored around the threads of the pipe leading into the opposite side of the valve. When castellated nuts are to be secured with safety wire, tighten the nut to the low side of the selected torque range, unless otherwise specified; and, if necessary, continue tightening until a slot lines with the hole. In blind tapped hole applications of bolts or castellated nuts on studs, the safety wiring should be in accordance with the general instructions of this chapter. Hollow-head bolts are safetied in the manner prescribed for regular bolts.

NOTE: Do not loosen or tighten properly tightened nuts to align safety-wire holes.

NOTE: Although there are numerous safety wiring techniques used to secure aircraft hardware, practically all are derived from the basic examples shown in figures 7-5 through 7-5b.

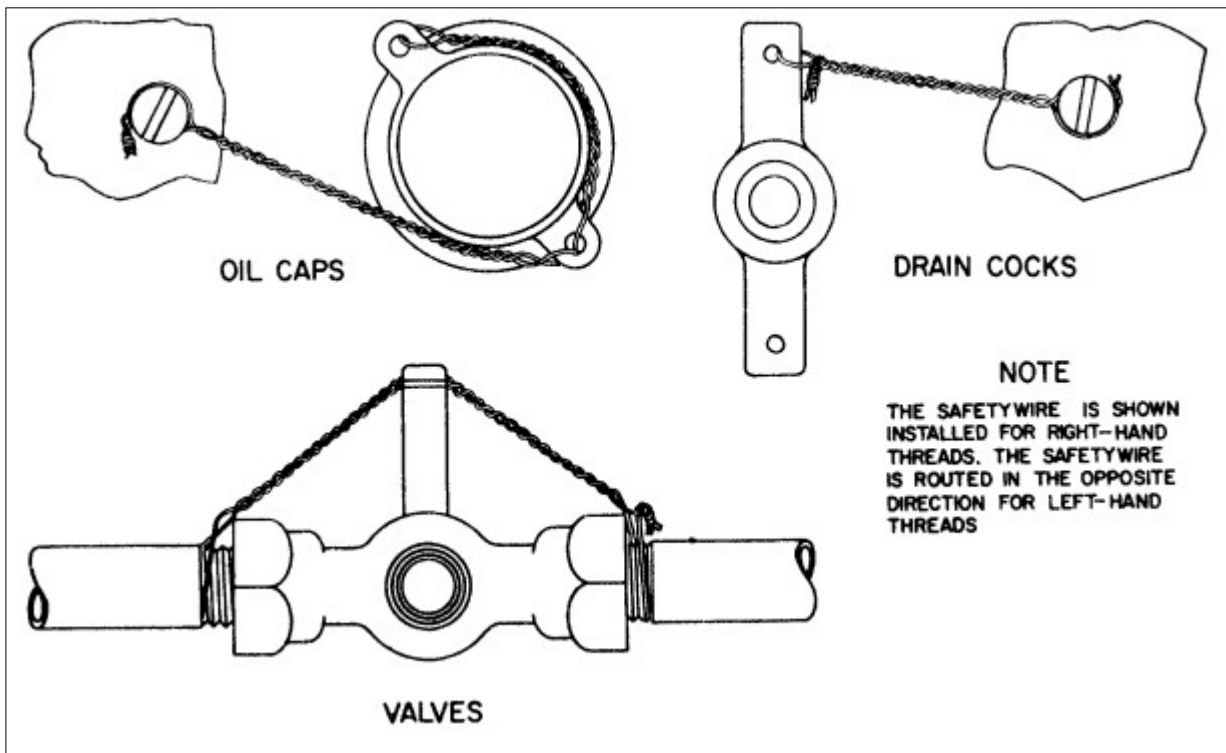

FIGURE 7-4a. Securing oil caps, drain cocks, and valves.

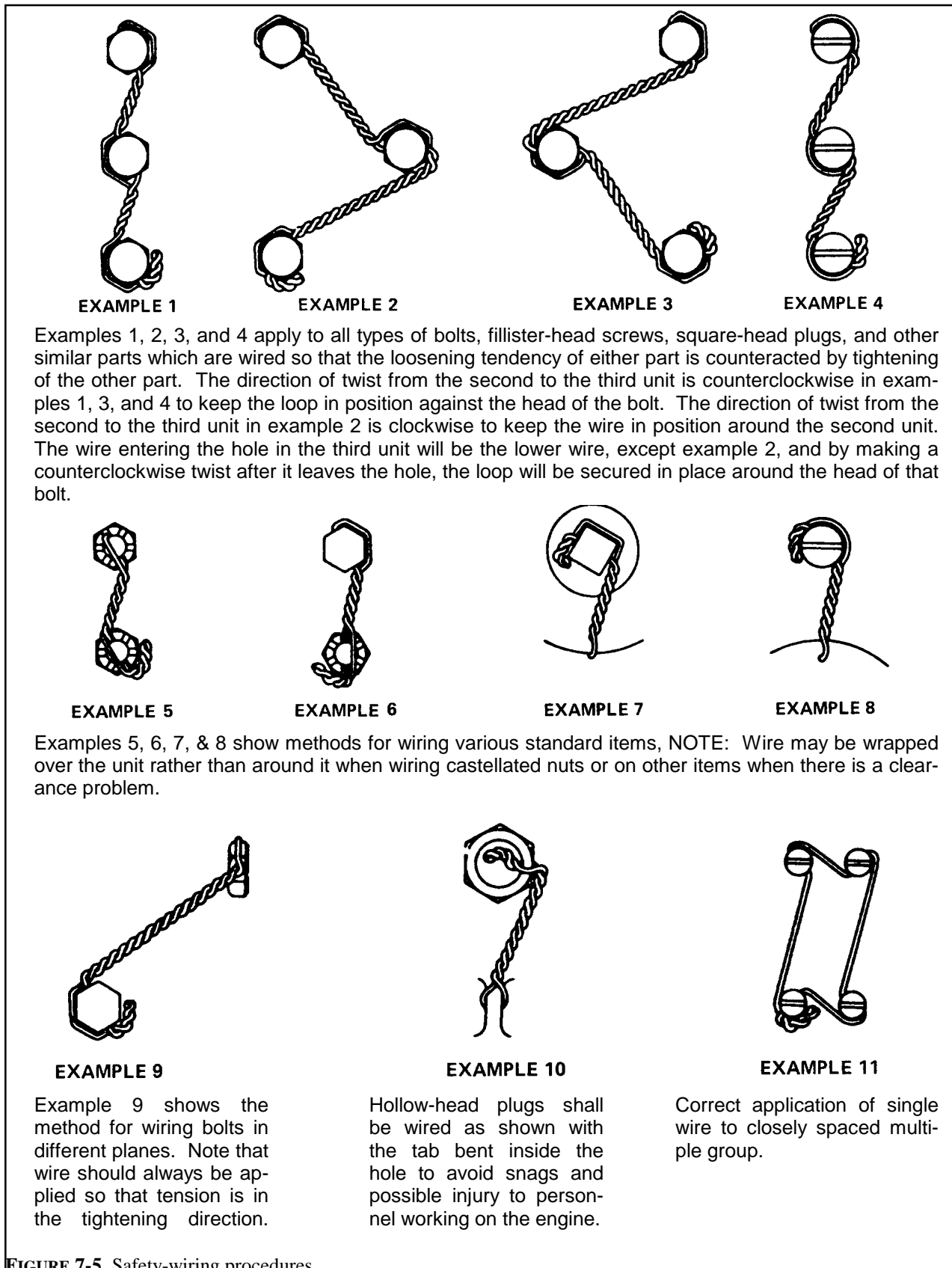

FIGURE 7-5. Safety-wiring procedures.

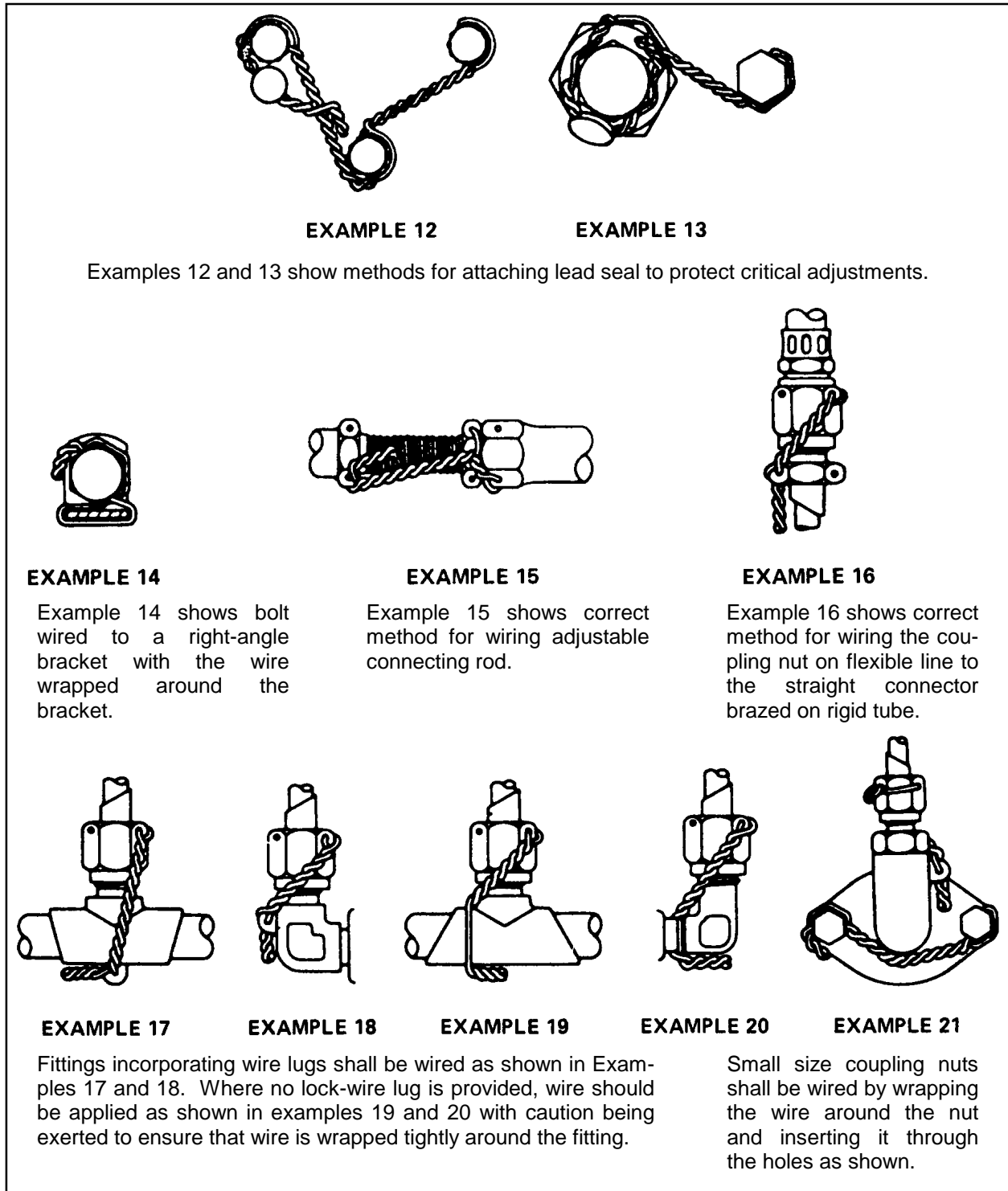

FIGURE 7-5a. Safety-wiring procedures.

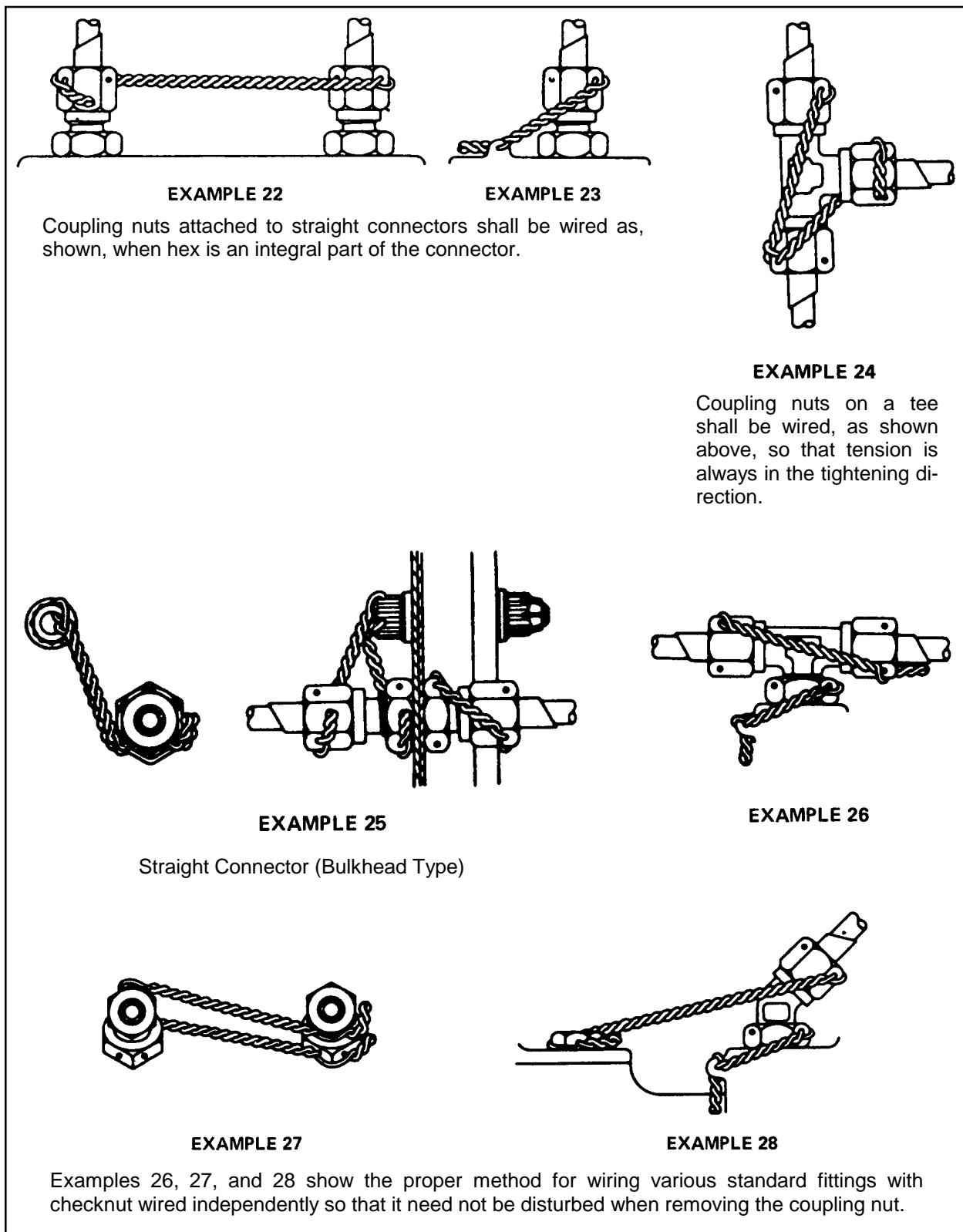

FIGURE 7-5b. Safety-wiring procedures.

7-127. SECURING WITH COTTER PINS.

a. **Cotter pins** are used to secure such items as bolts, screws, pins, and shafts. Their use is favored because they can be removed and installed quickly. The diameter of the cotter pins selected for any application should be the largest size that will fit consistent with the diameter of the cotter pin hole and/or the slots in the nut. Cotter pins should not be re-used on aircraft.

b. **To prevent injury** during and after pin installation, the end of the cotter pin can be rolled and tucked.

NOTE: In using the method of cotter pin safetying, as shown in figures 7-6 and 7-7, ensure the prong, bent over the bolt, is seated firmly against the bolt shank, and does not exceed bolt diameter. Also, when the prong is bent over the nut, ensure the bent prong is down and firmly flat against the nut and does not contact the surface of the washer.

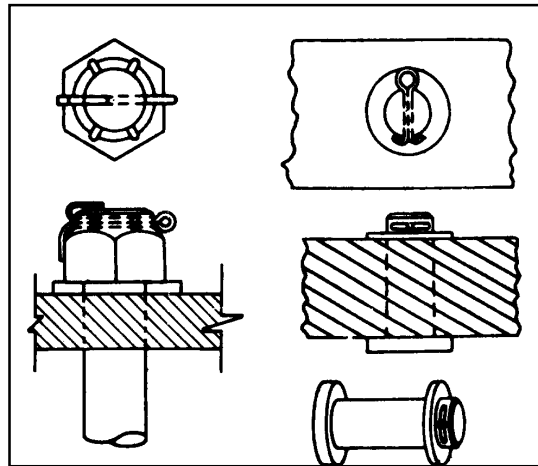

FIGURE 7-6. Securing with cotter pins.

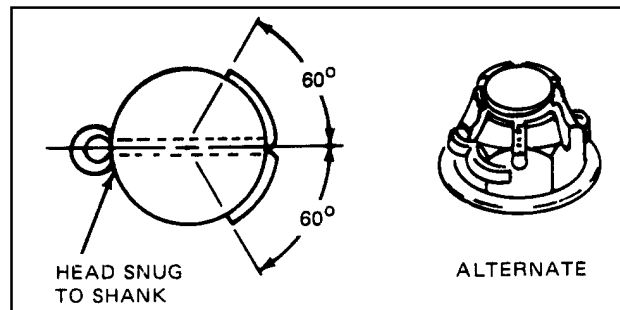

FIGURE 7-7. Alternate method for securing with cotter pins.

7-128.—7-139. [RESERVED.]

SECTION 8. INSPECTION AND REPAIR OF CONTROL CABLES AND TURNBUCKLES

7-140. GENERAL. Aircraft control cables are generally fabricated from carbon steel or corrosion-resistant steel wire of either flexible or nonflexible-type construction.

7-141. CABLE DEFINITIONS. The following cable components are defined in accordance with Military Specifications MIL-W-83420, MIL-C-18375, and MIL-W-87161.

a. Wire Center. The center of all strands shall be an individual wire and shall be designated as a wire center.

b. Strand Center or Core. A strand center is a single, straight strand made of preformed wires, similar to the other strands comprising the cable, in arrangement and number of wires.

c. Independent Wire Rope Center (IWRC) 7 by 7. A 7 by 7 independent wire rope center as specified herein shall consist of a cable or wire rope of six strands of seven wires each, twisted or laid around a strand center or core consisting of seven wires.

7-142. FLEXIBLE CABLES. Flexible, preformed, carbon steel, Type I, composition A cables, MIL-W-83420, are manufactured from steel made by the acid-open-hearth, basic-open hearth, or electric-furnace process. The wire used is coated with pure tin or zinc. Flexible, preformed, corrosion-resistant, Type I, composition B cables, MIL-W-87161, MIL-W-83420, and MIL-C-18375 are manufactured from steel made by the electric-furnace process. (See table 7-3 and figure 7-8.) These cables are of the 3 by 7, 7 by 7, 7 by 19, or 6 by 19 IWRC construction, according to the diameter as specified in table 7-3. The 3 by 7 cable consists of three

strands of seven wires each. There is no core in this construction. The 3 by 7 cable has a length of lay of not more than eight times or less than five times the nominal cable diameter. The 7 by 7 cable consists of six strands, of seven wires each, laid around a center strand of seven wires. The wires are laid so as to develop a cable which has the greatest bending and wearing properties. The 7 by 7 cable has a length of lay of not more than eight times or less than six times the cable diameter. The 7 by 19 cable consists of six strands laid around a center strand in a clockwise direction. The wires composing the seven individual strands are laid around a center wire in two layers. The center core strand consists of a lay of six wires laid around the central wire in a clockwise direction and a layer of 12 wires laid around this in a clockwise direction. The six outer strands of the cable consist of a layer of six wires laid around the center wire in a counterclockwise direction and a layer of 12 wires laid around this in a counterclockwise direction. The 6 by 19 cable consists of six strands of 19 wires each, laid around a 7 by 7. MIL-C-18375 cable, although not as strong as MIL-W-83420, is equal in corrosion resistance and superior in non-magnetic and coefficient of thermal expansion properties.

7-143. NYLON-COATED CABLES.

a. Nylon-coated cable is made by extruding a flexible nylon coating over corrosion-resistant steel (CRES) cable. The bare CRES cable must conform and be qualified to MIL-W-83420. After coating, the jacketed cable must still conform to MIL-W-83420.

b. The service life of nylon-coated cable is much greater than the service life of the same cable when used bare. Most cable wear occurs at pulleys where the cable bends. Wear

TABLE 7-3. Flexible cable construction and physical properties.

				MINIMUM BREAKING STRENGTH (Pounds)		
NOMINAL DIAMETER OF WIRE ROPE CABLE	CONSTRUCTION	TOLERANCE ON DIAMETER (PLUS ONLY)	ALLOWABLE INCREASE OF DIAMETER AT CUT END	MIL-W-83420 COMP A	MIL-W-83420 COMP B (CRES)	MIL-C-18375 (CRES)
INCHES		INCHES	INCHES	LBS	LBS	LBS
1/32	3 x 7	0.006	0.006	110	110	
3/64	7 x 7	0.008	0.008	270	270	
1/16	7 x 7	0.010	0.009	480	480	360
1/16	7 x 19	0.010	0.009	480	480	
3/32	7 x 7	0.012	0.010	920	920	700
3/32	7 x 19	0.012	0.010	1,000	920	
1/8	7 x 19	0.014	0.011	2,000	1,760	1,300
5/32	7 x 19	0.016	0.017	2,800	2,400	2,000
3/16	7 x 19	0.018	0.019	4,200	3,700	2,900
7/32	7 x 19	0.018	0.020	5,600	5,000	3,800
1/4	7 x 19	0.018	0.021	7,000	6,400	4,900
9/32	7 x 19	0.020	0.023	8,000	7,800	6,100
5/16	7 x 19	0.022	0.024	9,800	9,000	7,600
11/32	7 x 19	0.024	0.025	12,500		
3/8	7 x 19	0.026	0.027	14,400	12,000	11,000
7/16	6 x 19 IWRC	0.030	0.030	17,600	16,300	14,900
1/2	6 x 19 IWRC	0.033	0.033	22,800	22,800	19,300
9/16	6 x 19 IWRC	0.036	0.036	28,500	28,500	24,300
5/8	6 x 19 IWRC	0.039	0.039	35,000	35,000	30,100
3/4	6 x 19 IWRC	0.045	0.045	49,600	49,600	42,900
7/8	6 x 19 IWRC	0.048	0.048	66,500	66,500	58,000
1	6 x 19 IWRC	0.050	0.050	85,400	85,400	75,200
1 - 1/8	6 x 19 IWRC	0.054	0.054	106,400	106,400	
1 - 1/4	6 x 19 IWRC	0.057	0.057	129,400	129,400	
1 - 3/8	6 x 19 IWRC	0.060	0.060	153,600	153,600	
1 - 1/2	6 x 19 IWRC	0.062	0.062	180,500	180,500	

is caused by friction between strands and between wires. In bare cable, this is aggravated by dirt and grit working its way into the cable; and the lubricant working its way out leaving dry, dirty wires rubbing against each other. In long, straight runs of cable, vibration work-hardens the wires causing the brittle wires to fracture with eventual failure of the cable.

c. The nylon-jacket protects the cable in a threefold manner. It keeps the lubricant from oozing out and evaporating, it keeps dirt and grit out, and it dampens the vibrations,

thereby, greatly reducing their effect on the cable.

7-144. NONFLEXIBLE CABLES. (Refer to table 7-4 and figure 7-9.) Nonflexible, pre-formed, carbon steel cables, MIL-W-87161, composition A, are manufactured by the same processes as MIL-W-83420, composition B, flexible corrosion-resistant steel cables. The nonflexible steel cables are of the 1 by 7 (Type I) or 1 by 19 (Type II) construction according to the diameter as specified in table 7-4. The 1 by 7 cable consists of six

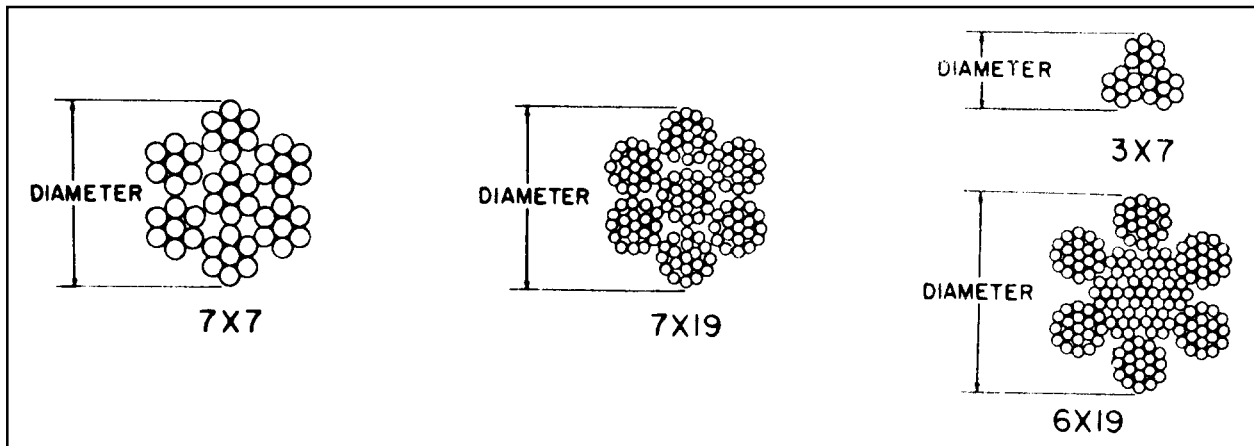

FIGURE 7-8. Flexible cable cross section.

TABLE 7-4. Nonflexible cable construction and physical properties.

STRAND TYPE	NOMINAL DIAMETER OF WIRE STRAND In.	TOLERANCE ON DIAMETER (Plus Only) In.	ALLOWABLE INCREASE IN DIAMETER AT THE END In.	CONSTRUCTION	MIL-W-87161 MINIMUM BREAK STRENGTH COMP A & B Lbs.
I	1/32	0.003	0.006	1 x 7	185
I	3/64	0.005	0.008	1 x 7	375
II	3/64	0.005	0.008	1 x 19	375
I	1/16	0.006	0.009	1 x 7	500
II	1/16	0.006	0.009	1 x 19	500
II	5/64	0.008	0.009	1 x 19	800
II	3/32	0.009	0.010	1 x 19	1,200
II	7/64	0.009	0.010	1 x 19	1,600
II	1/8	0.013	0.011	1 x 19	2,100
II	5/32	0.013	0.016	1 x 19	3,300
II	3/16	0.013	0.019	1 x 19	4,700
II	7/32	0.015	0.020	1 x 19	6,300
II	1/4	0.018	0.021	1 x 19	8,200
II	5/16	0.022	0.024	1 x 19	12,500
II	3/8	0.026	0.027	1 x 19	17,500

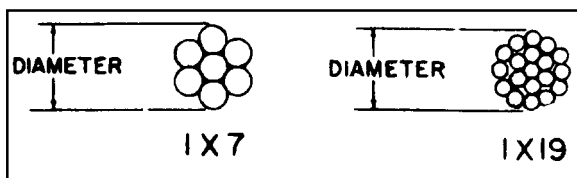

FIGURE 7-9. Nonflexible cable cross section.

wires laid around a center wire in a counter-clockwise direction. The 1 by 19 cable consists of a layer of six wires laid around a center wire in a clockwise direction plus twelve wires laid around the inner strand in a counterclockwise direction.

7-145. CABLE SPECIFICATIONS. Cable diameter and strength data are given in table 7-3 and table 7-4. These values are acceptable for repair and modification of civil aircraft.

7-146. CABLE PROOF LOADS. Cable terminals and splices should be tested for proper strength before installation. Gradually apply a test load equal to 60 percent of the cable-breaking strengths given in table 7-3 and

table 7-4, for a period of 3 minutes. Place a suitable guard over the cable during the test to prevent injury to personnel in the event of cable failure.

7-147. REPLACEMENT OF CABLES.

Replace control cables when they become worn, distorted, corroded, or otherwise damaged. If spare cables are not available, prepare exact duplicates of the damaged cable. Use materials of the same size and quality as the original. Standard swaged cable terminals develop the full cable strength and may be substituted for the original terminals wherever practical. However, if facilities and supplies are limited and immediate corrective action is necessary, repairs may be made by using cable bushings, eye splices, and the proper combination of turnbuckles in place of the original installation. (See figure 7-12(c).)

a. Location of Splices. Locate splices so that no portion of the splice comes closer than 2 inches to any fair-lead or pulley. Locate connections at points where jamming cannot occur during any portion of the travel of either the loaded cable or the slack cable in the deflected position.

b. Cutting and Heating. Cut cables to length by mechanical means. The use of a torch, in any manner, is not permitted. Do not subject wires and cables to excessive temperature. Soldering the bonding braid to the control cable is not permitted.

c. Ball-and-Socket Type Terminals. Do not use ball-and-socket type terminals or other types for general replacement that do not positively prevent cable untwisting, except where they were utilized on the original installation by the aircraft manufacturer.

d. Substitution of Cable. Substitution of cable for hard or streamlined wires will not be

acceptable unless specifically approved by a representative of the FAA.

7-148. MECHANICALLY-FABRICATED CABLE ASSEMBLIES.

a. Swage-Type Terminals. Swage-type terminals, manufactured in accordance with AN, are suitable for use in civil aircraft up to, and including, maximum cable loads. When swaging tools are used, it is important that all the manufacturers' instructions, including "go and no-go" dimensions, be followed in detail to avoid defective and inferior swaging. Observance of all instructions should result in a terminal developing the full-rated strength of the cable. Critical dimensions, both before and after swaging, are shown in table 7-5.

(1) Terminals. When swaging terminals onto cable ends, observe the following procedures.

(a) Cut the cable to the proper length allowing for growth during swaging. Apply a preservative compound to the cable ends before insertion into the terminal barrel.

NOTE: Never solder cable ends to prevent fraying, since the presence of the solder will greatly increase the tendency of the cable to pull out of the terminal.

(b) Insert the cable into the terminal approximately 1 inch, and bend toward the terminal, then push the cable end entirely into the terminal barrel. The bending action puts a kink or bend in the cable end, and provides enough friction to hold the terminal in place until the swaging operation can be performed. Bending also tends to separate the strands inside the barrel, thereby reducing the strain on them.

TABLE 7-5. Straight-shank terminal dimensions. (Cross reference AN to MS: AN-666 to MS 21259, AN-667 to MS 20667, AN-668 to MS 20668, AN-669 to MS 21260.)

Cable size (inches)	Wire strands	Before swaging				After swaging	
		Outside diameter	Bore diameter	Bore length	Swaging length	Minimum breaking strength (pounds)	Shank diameter *
1/16	7 x 7	0.160	0.078	1.042	0.969	480	0.138
3/32	7 x 7	.218	.109	1.261	1.188	920	.190
1/8	7 x 19	.250	.141	1.511	1.438	2,000	.219
5/32	7 x 19	.297	.172	1.761	1.688	2,800	.250
3/16	7 x 19	.359	.203	2.011	1.938	4,200	.313
7/32	7 x 19	.427	.234	2.261	2.188	5,600	.375
1/4	7 x 19	.494	.265	2.511	2.438	7,000	.438
9/32	7 x 19	.563	.297	2.761	2.688	8,000	.500
5/16	7 x 19	.635	.328	3.011	2.938	9,800	.563
3/8	7 x 19	.703	.390	3.510	3.438	14,400	.625

*Use gauges in kit for checking diameters.

NOTE: If the terminal is drilled completely through, push the cable into the terminal until it reaches the approximate position shown in figure 7-10. If the hole is not drilled through, insert the cable until the end rests against the bottom of the hole.

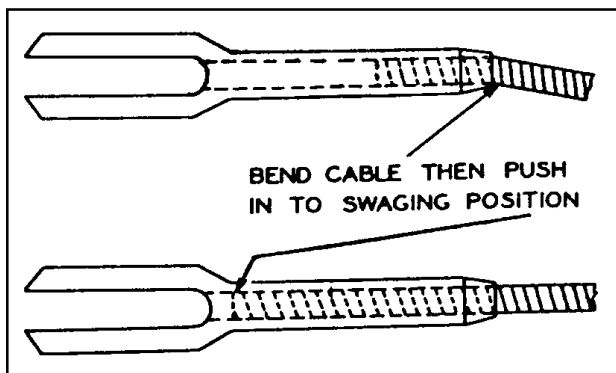

FIGURE 7-10. Insertion of cable into terminal.

(c) Accomplish the swaging operation in accordance with the instructions furnished by the manufacturer of the swaging equipment.

(d) Inspect the terminal after swaging to determine that it is free from the die marks and splits, and is not out-of-round. Check for

cable slippage in the terminal and for cut or broken wire strands.

(e) Using a “go no-go” gauge or a micrometer, check the terminal shank diameter as shown in figure 7-11 and table 7-5.

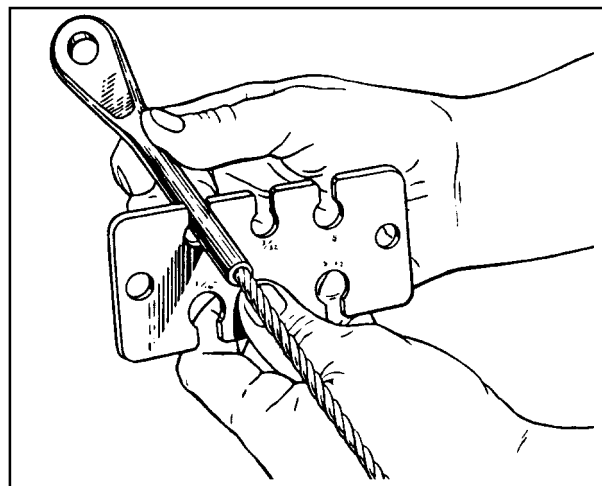

FIGURE 7-11. Gauging terminal shank after swaging.

(f) Test the cable by proof-loading it to 60 percent of its rated breaking strength.

(2) Splicing. Completely severed cables, or those badly damaged in a localized area, may be repaired by the use of an eye

terminal bolted to a clevis terminal. (See figure 7-12(a).) However, this type of splice can only be used in free lengths of cable which do not pass over pulleys or through fair-leads.

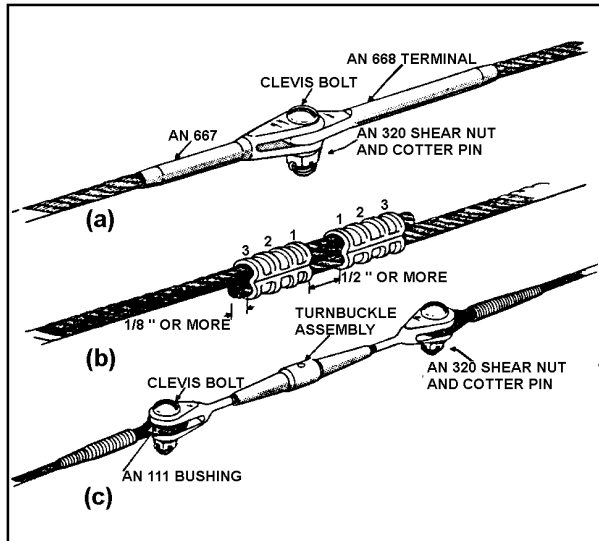

FIGURE 7-12. Typical cable splices.

(3) Swaged ball terminals. On some aircraft cables, swaged ball terminals are used for attaching cables to quadrants and special connections where space is limited. Single shank terminals are generally used at the cable ends, and double shank fittings may be used at either the end or in the center of the cable. Dies are supplied with the swaging machines for attaching these terminals to cables by the following method.

(a) The steel balls and shanks have a hole through the center, and are slipped over the cable and positioned in the desired location.

(b) Perform the swaging operation in accordance with the instructions furnished by the manufacturer of the swaging equipment.

(c) Check the swaged fitting with a “go no-go” gauge to see that the fitting is properly compressed, and inspect the physical condition of the finished terminal. (See figure 7-13.)

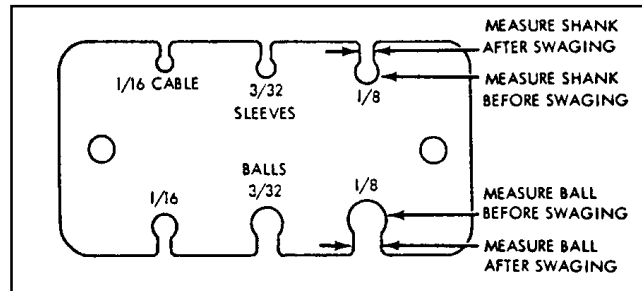

FIGURE 7-13. Typical terminal gauge.

(4) Cable slippage in terminal. Ensure that the cable is properly inserted in the terminal after the swaging operation is completed. Instances have been noted wherein only 1/4 inch of the cable was swaged in the terminal. Observance of the following precautions should minimize this possibility.

(a) Measure the length of the terminal end of the fitting to determine the proper length of cable to be inserted into the barrel of the fitting.

(b) Lay off this length at the end of the cable and mark with masking tape. Since the tape will not slip, it will provide a positive marking during the swaging process.

(c) After swaging, check the tape marker to make certain that the cable did not slip during the swaging operation.

(d) Remove the tape and paint the junction of the swaged fitting and cable with red tape.

(e) At all subsequent service inspections of the swaged fitting, check for a gap in the painted section to see if cable slippage has occurred.

b. Nicopress Process. A patented process using copper sleeves may be used up to the full rated strength of the cable when the cable is looped around a thimble. This process may also be used in place of the five-tuck splice on

cables up to and including 3/8 inch diameter. The use of sleeves that are fabricated of materials other than copper will require engineering approval for the specific application by the FAA.

(1) Before undertaking a nicopress splice, determine the proper tool and sleeve for the cable to be used. Refer to table 7-6 and table 7-7 for details on sleeves, tools, and the number of presses required for the various sizes of aircraft cable. The tool must be in good working condition and properly adjusted to ensure a satisfactory splice.

(2) To compress a sleeve, have it well-centered in the tool groove with the major axis of the sleeve at right angles to the tool. If the sleeve appears to be out of line after the press is started, open the tool, re-center the sleeve, and complete the press.

c. Thimble-Eye Splice. Before undertaking a thimble-eye splice, initially position the cable so the end will extend slightly beyond the sleeve, as the sleeve will elongate somewhat when it is compressed. If the cable end is inside the sleeve, the splice may not hold the full strength of the cable. It is desirable that the oval sleeve be placed in close proximity to the thimble points, so that when compressed, the sleeve will contact the thimble as shown in figure 7-14. The sharp ends of the thimble may be cut off before being used; however, make certain the thimble is firmly secured in the cable loop after the splice has been completed. When using a sleeve requiring three compressions, make the center compression first, the compression next to the thimble second, and the one farthest from the thimble last.

d. Lap Splice. Lap or running splices may also be made with copper oval sleeves. When making such splices, it is usually necessary to use two sleeves to develop the full

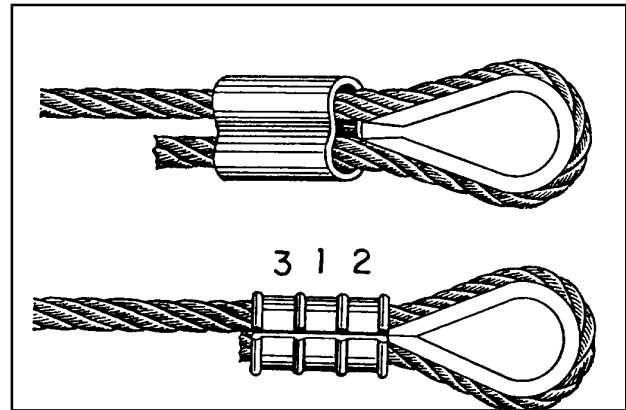

FIGURE 7-14. Typical thimble-eye splice.

strength of the cable. The sleeves should be positioned as shown in figure 7-12(b), and the compressions made in the order shown. As in the case of eye splices, it is desirable to have the cable ends extend beyond the sleeves sufficiently to allow for the increased length of the compressed sleeves.

e. Stop Sleeves. Stop sleeves may be used for special cable end and intermediate fittings. They are installed in the same manner as nicopress oval sleeves.

NOTE: All stop sleeves are plain copper. Certain sizes are colored for identification.

f. Terminal Gauge. To make a satisfactory copper sleeve installation, it is important that the amount of sleeve pressure be kept uniform. The completed sleeves should be checked periodically with the proper gauge. Hold the gauge so that it contacts the major axis of the sleeve. The compressed portion at the center of the sleeve should enter the gauge opening with very little clearance, as shown in figure 7-15. If it does not, the tool must be adjusted accordingly.

g. Other Applications. The preceding information regarding copper oval sleeves and stop sleeves is based on tests made with flexible aircraft cable. The sleeves may also be

TABLE 7-6. Copper oval sleeve data.

Cable size	Copper oval sleeve stock No.		Manual tool No.	Sleeve length before compression (approx.) (inches)	Sleeve length after compression (approx.) (inches)	Number of presses	Tested strength (pounds)
	Plain	Plated*					
3/64	18-11-B4	28-11-B4	51-B4-887	3/8	7/16	1	340
1/16	18-1-C	28-1-C	51-C-887	3/8	7/16	1	550
3/32	18-2-G	28-2-G	51-G-887	7/16	1/2	1	1,180
1/8	18-3-M	28-3-M	51-M-850	9/16	3/4	3	2,300
5/32	18-4-P	28-4-P	51-P-850	5/8	7/8	3	3,050
3/16	18-6-X	28-6-X	51-X-850	1	1 1/4	4	4,350
7/32	18-8-F2	28-8-F2	51-F2-850	7/8	1 1/16	4	5,790
1/4	18-10-F6	28-10-F6	3-F6-950	1 1/8	1 1/2	3	7,180
5/16	18-13-G9	28-13-G9	3-G9-950	1 1/4	1 5/8	3	11,130
			No. 635 Hydraulic tool dies				
3/8	18-23-H5	28-23-H5	Oval H5	1 1/2	1 7/8	1	16,800
7/16	18-24-J8	28-24-J8	Oval J8	1 3/4	2 1/8	2	19,700
1/2	18-25-K8	28-25-K8	Oval K8	1 7/8	2 1/2	2	25,200
9/16	18-27-M1	28-27-M1	Oval M1	2	2 5/8	3	31,025
5/8	18-28-N5	28-28-N5	Oval N5	2 3/8	3 1/8	3	39,200

*Required on stainless cables due to electrolysis caused by different types of metals.

TABLE 7-7. Copper stop sleeve data.

Cable size (inch)	Sleeve No.	Tool No.	Sleeve	Sleeve	Tested strength (pounds)
3/64	871-12-B4	51-B4-887	7/32	11/64	280
1/16	871-1-C	51-C-887	7/32	13/64	525
3/32	871-17-J (Yellow)	51-MJ	5/16	21/64	600
1/8	S71-18-J (Red)	51-MJ	5/16	21/64	800
5/32	871-19-M	51-MJ	5/16	27/64	1,200
3/16	871-20-M (Black)	51-MJ	5/16	27/64	1,600
7/32	871-22-M	51-MJ	5/8	7/16	2,300
1/4	871-23-F6	3-F6-950	11/16	21/32	3,500
5/16	871-26-F6	3-F6-950	11/16	21/32	3,800

NOTE: All stop sleeves are plain copper. Certain sizes are colored for identification.

used on wire ropes of other construction, if each specific type of cable is proof-tested initially. Because of variation in rope strengths, grades, construction, and actual diameters, the test is necessary to insure proper selection of materials, the correct pressing procedure, and an adequate margin of safety for the intended use.

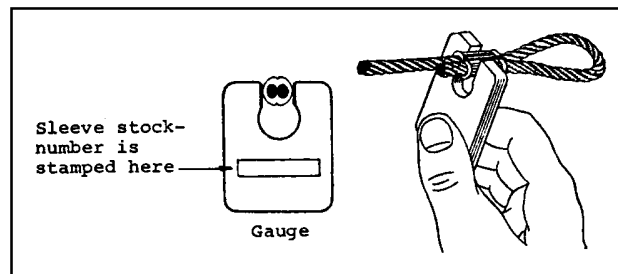

FIGURE 7-15. Typical terminal gauge.

7-149. CABLE SYSTEM INSPECTION.

Aircraft cable systems are subject to a variety of environmental conditions and deterioration. Wire or strand breakage is easy to visually recognize. Other kinds of deterioration such as wear, corrosion, and/or distortion are not easily seen; therefore, control cables should be removed periodically for a more detailed inspection.

a. At each annual or 100 hour inspection, all control cables must be inspected for broken wires strands. Any cable assembly that has one broken wire strand located in a critical fatigue area must be replaced.

b. A critical fatigue area is defined as the working length of a cable where the cable runs over, under, or around a pulley, sleeve, or through a fair-lead; or any section where the cable is flexed, rubbed, or worked in any manner; or any point within 1 foot of a swaged-on fitting.

c. A swaged-on fitting can be an eye, fork, ball, ball and shank, ball and double shank, threaded stud, threaded stud and turn-buckle, compression sleeve, or any hardware used as a termination or end fitting on the cable. These fittings may be attached by various swaging methods such as rotary swaging, roll swaging, hydraulic pressing, and hand swaging tools. (See MIL-T-781.) The pressures exerted on the fittings during the swaging process sometimes pinch the small wires in the cable. This can cause premature failure of the pinched wires, resulting in broken wires.

d. Close inspection in these critical fatigue areas, must be made by passing a cloth over the area to snag on broken wires. This will clean the cable for a visual inspection, and detect broken wires if the cloth snags on the cable. Also, a very careful visual inspection

must be made since a broken wire will not always protrude or stick out, but may lie in the strand and remain in the position of the helix as it was manufactured. Broken wires of this type may show up as a hairline crack in the wire. If a broken wire of this type is suspected, further inspection with a magnifying glass of 7 power or greater, is recommended. Figure 7-16 shows a cable with broken wires that was not detected by wiping, but was found during a visual inspection. The damage became readily apparent when the cable was removed and bent as shown in figure 7-16.



FIGURE 7-16. Cable inspection technique.

e. Kinking of wire cable can be avoided if properly handled and installed. Kinking is caused by the cable taking a spiral shape as the result of unnatural twist. One of the most common causes for this twist is improper unreeling and uncoiling. In a kinked cable, strands and wires are out of position, which creates unequal tension and brings excessive wear at this part of the cable. Even though the kink may be straightened so that the damage appears to be slight, the relative adjustment between the strands has been disturbed so that the cable cannot give maximum service and should be replaced. Inspect cables for a popped core or loose strands. Replace any cable that has a popped core or loose strands regardless of wear or broken wires.

f. Nylon-jacketed cable with any cracks or necking down in the diameter of the jacket shall be replaced. Usable cable life is over when these conditions begin to appear in the nylon jacket.

g. External wear patterns will extend along the cable equal to the distance the cable moves at that location and may occur on one side of the cable or on its entire circumference. Replace flexible and nonflexible cables when the individual wires in each strand appear to blend together (outer wires worn 40 to 50 percent) as depicted in figure 7-17. Actual instances of cable wear beyond the recommended replacement point are shown in figure 7-18.

h. As wear is taking place on the exterior surface of a cable, the same condition is taking place internally, particularly in the sections of the cable which pass over pulleys and quadrants. This condition (shown in figure 7-19) is not easily detected unless the strands of the cable are separated. This type of wear is a result of the relative motion between inner wire surfaces. Under certain conditions, the rate of this type of wear can be greater than that occurring on the surface.

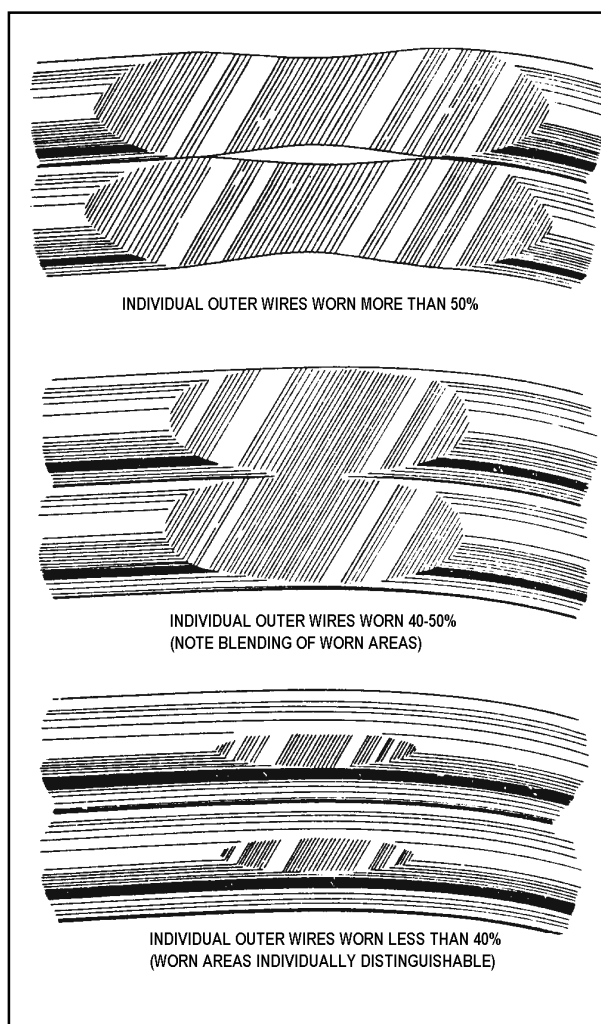

FIGURE 7-17. Cable wear patterns.



FIGURE 7-18. Worn cable (replacement necessary).

i. Areas especially conducive to cable corrosion are battery compartments, lavatories, wheel wells, etc.; where a concentration of corrosive fumes, vapors, and liquids can accumulate. Carefully examine any cable for corrosion, when it has a broken wire in a section that is not in contact with a wear-producing airframe component, such as a pulley, fair-lead, etc. If the surface of the cable is corroded, relieve cable tension and carefully force the cable open by reverse twisting and visually inspect the interior. Corrosion on the interior strands of the cable constitutes failure, and the cable must be replaced. If no internal corrosion is detected, remove loose external rust and corrosion with a clean, dry, coarse-weave rag, or fiber brush. Do not use metallic

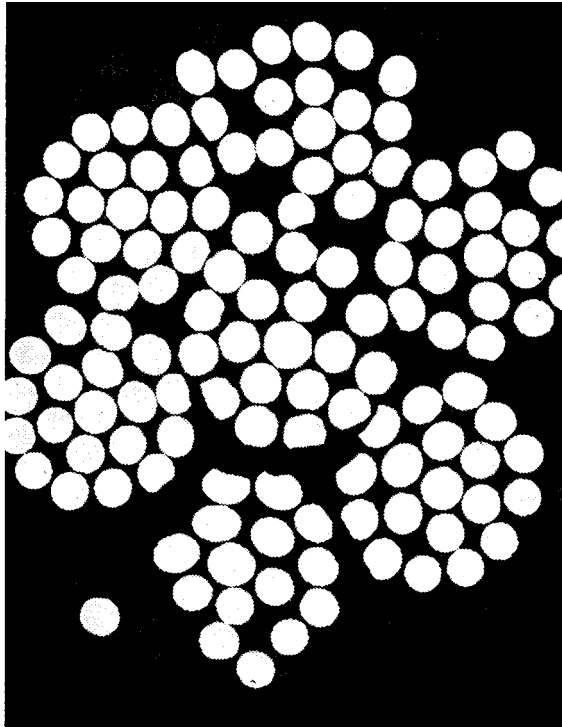

FIGURE 7-19. Internal end view of cable wear.

wool or solvents to clean installed cables. Use of metallic wool will embed dissimilar metal particles in the cables and create further corrosion problems. Solvents will remove internal cable lubricant allowing cable strands to abrade and further corrode. After thorough cleaning, sparingly apply specification MIL-C-16173, grade 4, corrosion-preventive compound to cable. Do not apply the material so thick that it will interfere with the operation of cables at fair-leads, pulleys, or grooved bellcrank areas.

j. Examine cable runs for incorrect routing, fraying, twisting, or wear at fair-leads, pulleys, antiabrasion strips, and guards. Look for interference with adjacent structure, equipment, wiring, plumbing, and other controls. Inspect cable systems for binding, full travel, and security of attaching hardware. Check for slack in the cable system by attempting to move the control column and/or pedals while the gust locks are installed on the control surfaces. With the gust locks removed,

actuate the controls and check for friction or hard movement. These are indications that excessive cable tension exists.

NOTE: If the control movement is stiff after maintenance is performed on control surfaces, check for parallel cables twisted around each other, or cables connected in reverse.

k. Check swaged terminal reference marks for an indication of cable slippage within the fitting. Inspect the fitting assembly for distortion and/or broken strands at the terminal. Ensure that all bearings and swivel fittings (bolted or pinned) pivot freely to prevent binding and subsequent failure. Check turnbuckles for proper thread exposure and broken or missing safety wires/clips.

l. Inspect pulleys for roughness, sharp edges, and presence of foreign material embedded in the grooves. Examine pulley bearings to ensure proper lubrication, smooth rotation; and freedom from flat spots, dirt, and paint spray. During the inspection, rotate the pulleys, which only turn through a small arc, to provide a new bearing surface for the cable. Maintain pulley alignment to prevent the cable from riding on the flanges and chafing against guards, covers, or adjacent structure. Check all pulley brackets and guards for damage, alignment, and security.

m. Various cable system malfunctions may be detected by analyzing pulley conditions. These include such discrepancies as too much tension, misalignment, pulley bearing problems, and size mismatches between cables and pulleys. Examples of these condition are shown in figure 7-20.

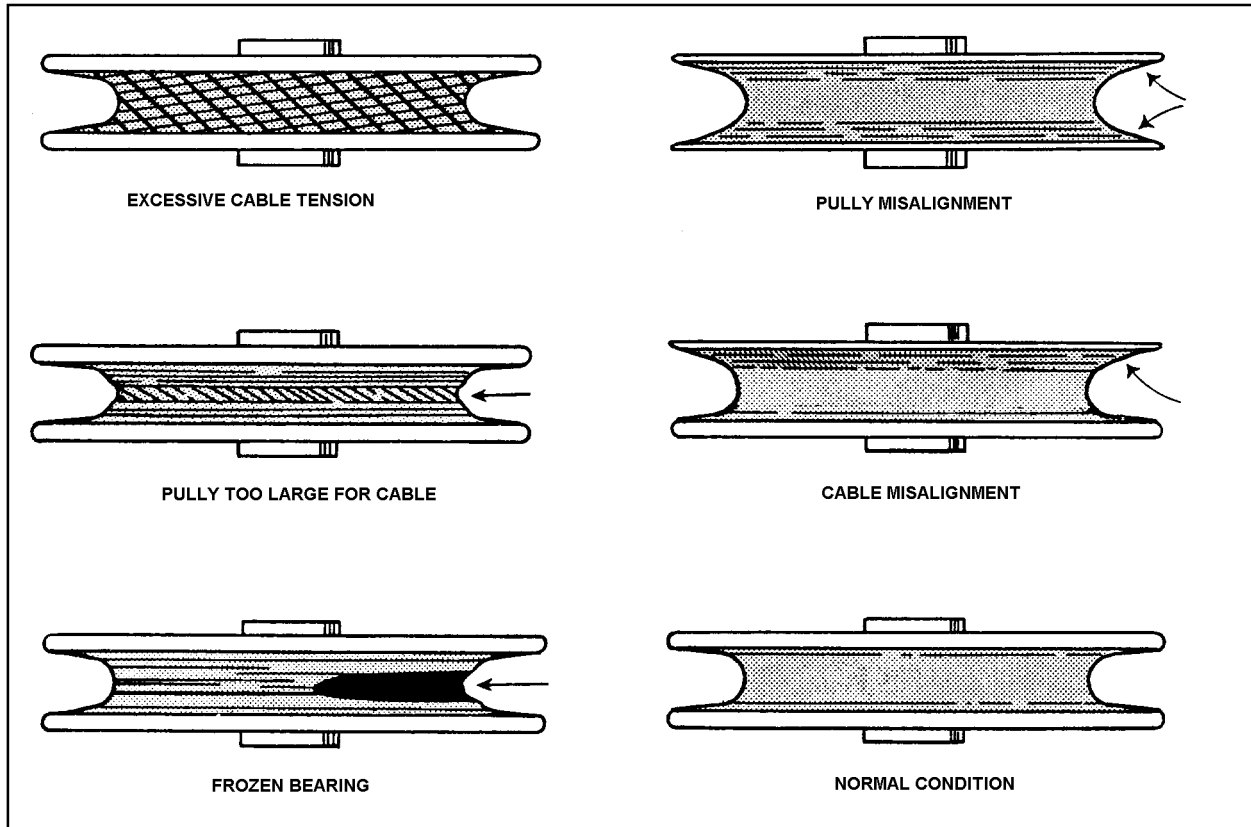

FIGURE 7-20. Pulley wear patterns.

n. Inspect fair-leads for wear, breakage, alignment, cleanliness, and security. Examine cable routing at fair-leads to ensure that deflection angles are no greater than 3° maximum. Determine that all guides and anti-abrasion strips are secure and in good condition.

o. Examine pressure seals for wear and/or material deterioration. Seal guards should be positioned to prevent jamming of a pulley in case pressure seal fails and pieces slide along the cable.

7-150. CORROSION AND RUST PREVENTION. To ensure a satisfactory service life for aircraft control cables, use a cable lubricant to reduce internal friction and prevent corrosion.

a. If the cable is made from tinned steel, coat the cable with rust-preventive oil, and

wipe off any excess. It should be noted that corrosion-resistant steel cable does not require this treatment for rust prevention.

b. Lubrication and corrosion preventive treatment of carbon steel cables may be effected simultaneously by application of compound MIL-C-16173, grade 4, or MIL-C-11796, Class I. MIL-C-16173 compound should be brushed, sprayed, or wiped on the cable to the extent it penetrates into the strands and adequately covers the cable surfaces. It will dry "tack free" in 24 hours at 77°F . MIL-C-11796 compound is applied by dipping the cable for 1/2 minute into a tank of compound heated to $77^{\circ} \pm 5^{\circ}\text{C}$ ($170^{\circ} \pm 9^{\circ}\text{F}$) for 1/2 minute then removing it and wiping off the excess oil. (An example of cable corrosion, attributable to battery acid, is shown in figure 7-21.)

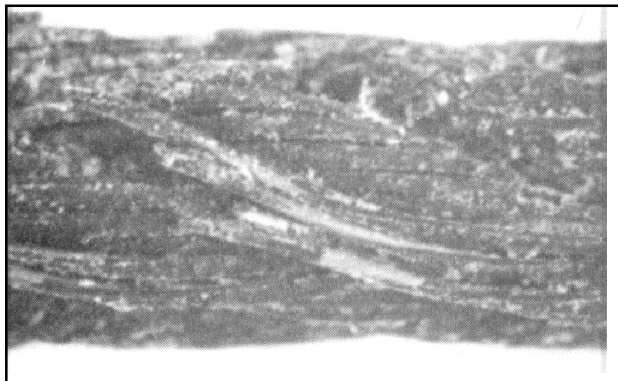

FIGURE 7-21. Corrosion.

7-151. WIRE SPLICES. Standard manufacturing splices have been mistaken for defects in the cable because individual wire end splices were visible after assembly of a finished cable length. In some instances, the process of twisting outer strands around the core strand may also slightly flatten individual outer wires, particularly in the area of a wire splice. This flattening is the result of die-sizing the cable, and does not affect the strength of the cable. These conditions (as shown in figure 7-22) are normal, and are not a cause for cable rejection.

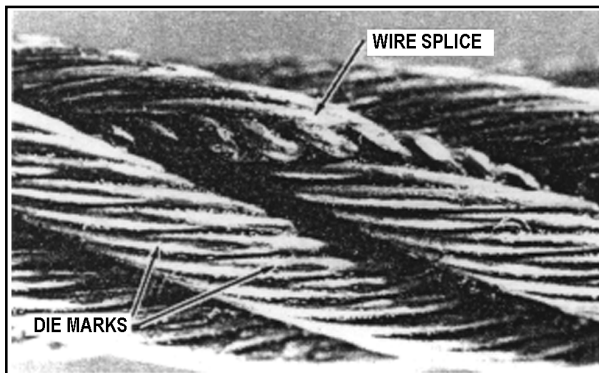

FIGURE 7-22. Manufacturer's wire splice.

7-152. CABLE MAINTENANCE. Frequent inspections and preservation measures such as rust-prevention treatments for bare carbon steel cable areas, will help to extend cable service life. Where cables pass through fair-leads, pressure seals, or over pulleys, remove accumulated heavy coatings of corrosion-prevention compound. Provide corrosion protection for these cable sections by lubricating with a light coat of grease or general-purpose, low-temperature oil.

7-153. CABLE TENSION ADJUSTMENT. Carefully adjust, control cable tension in accordance with the airframe manufacturer's recommendations. On large aircraft, take the temperature of the immediate area into consideration when using a tension meter. For long cable sections, use the average of two or three temperature readings to obtain accurate tension values. If necessary, compensate for extreme surface temperature variations that may be encountered if the aircraft is operated primarily in unusual geographic or climatic conditions such as arctic, arid, or tropic locations. Use rigging pins and gust locks, as necessary, to ensure satisfactory results. At the completion of rigging operations, check turnbuckle adjustment and safetying in accordance with section 10 of this chapter.

7-154.—7-164. [RESERVED.]

SECTION 9. TURNBUCKLES

7-165. GENERAL. A turnbuckle is a device used in cable systems to provide a means of adjusting tension. Turnbuckles have barrel-shaped sleeves with internal left- and right-hand threads at opposite ends. The cables, with terminals attached, are made to such a length that, when the turnbuckle is adjusted to give the specified cable tension, a sufficient number of threads on the terminal ends are screwed into the barrel to hold the load. The clip-locking turnbuckle and its associated parts are identical to standard AN and MS parts except for a slot grooved on the interior of the barrel and the shanks of the forks, eyes, etc. The clip-locking turnbuckle parts have the following drawing numbers: MS21251, turnbuckle body; MS21252, turnbuckle clevis end; MS21253, turnbuckle clevis end (for bearing); NAS649 and NAS651, turnbuckle clip; MS21254 and NAS648, turnbuckle eye (for pin); MS21255 and NAS647, turnbuckle eye end (for wire rope); NAS645 and NAS646, turnbuckle fork; MS21256, turnbuckle barrel locking clip; AN130-170, turnbuckle assemblies; and, MS21259 and MS21260, terminal, wire rope, stud.

NOTE: Turnbuckles showing signs of thread distortion/bending should be replaced. Turnbuckle ends are designed for providing the specified cable tension on a cable system, and a bent turnbuckle would place undesirable stress on the cable, impairing the function of the turnbuckle.

7-166. TURNBUCKLE INSTALLATION. (See figure 7-25.) When installing cable system turnbuckles, it is necessary to screw both threaded terminals into the turnbuckle barrel an equal amount. It is essential that turnbuckle terminals be screwed into the barrel so that not more than three threads on the terminal are exposed. (See figure 7-23A.) On initial installation, the turnbuckle terminals should not be screwed inside the turnbuckle barrel more than four threads. (See figure 7-23B.)

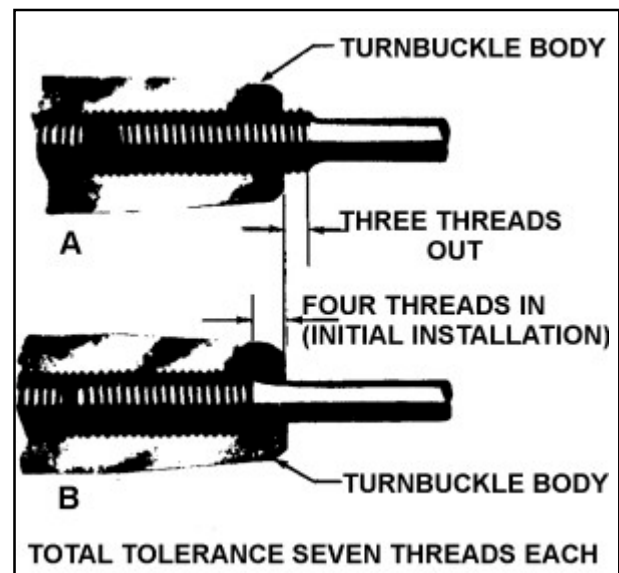

FIGURE 7-25. Turnbuckle thread tolerance.

7-167. WITNESS HOLE. Some manufacturers of turnbuckles incorporate a “witness hole,” in the turnbuckle barrel to ensure that the threaded cable terminals are screwed in far enough into the barrel. The “witness hole” can be inspected visually, or by using a piece of safety wire as a probe.

7-168.—7-178. [RESERVED.]

SECTION 10. SAFETY METHODS FOR TURNBUCKLES

7-179. GENERAL. Safety all turnbuckles with safety wire using either the double or single-wrap method, or with any appropriately approved special safetying device complying with the requirements of FAA Technical Standard Order TSO-C21. The swaged and unswaged turnbuckle assemblies are covered by AN standard drawings. Do not reuse safety wire. Adjust the turnbuckle to the correct cable tension so that no more than three cable threads are exposed on either side of the turnbuckle barrel.

7-180. DOUBLE-WRAP METHOD. Of the methods using safety wire for safetying turnbuckles, the method described here is preferred, although either of the other methods described is satisfactory. The method of double-wrap safetying is shown in figure 7-26(A).

a. Use two separate lengths of wire. Run one end of the wire through the hole in the barrel of the turnbuckle and bend the ends of the wire toward opposite ends of the turnbuckle.

b. Pass the second length of the wire into the hole in the barrel and bend the ends along the barrel on the side opposite the first. Spiral the two wires in opposite directions around the barrel to cross each other twice between the center hole and the ends.

c. Then pass the wires at the end of the turnbuckle in opposite directions through the hole in the turnbuckle eyes or between the jaws of the turnbuckle fork, as applicable, laying one wire along the barrel and wrapping the other at least four times around the shank of the turnbuckle and binding the laid wires in place before cutting the wrapped wire off.

d. Wrap the remaining length of safety wire at least four turns around the shank and cut it off. Repeat the procedure at the opposite end of the turnbuckle.

e. When a swaged terminal is being safetyed, pass the ends of both wires through the hole provided in the terminal for this purpose and wrap both ends around the shank as previously described. If the hole is not large enough to allow passage of both wires, pass the wire through the hole and loop it over the free end of the other wire, and then wrap both ends around the shank as previously described. Another satisfactory double-wrap method is similar to the previous method, except that the spiraling of the wires is omitted as shown in figure 7-26(B).

7-181. SINGLE-WRAP METHOD. The single-wrap methods described in the following paragraphs and as illustrated in figure 7-26(C) and (D) are acceptable, but are not the equal of the double-wrap methods.

a. Pass a single length of wire through the cable eye or fork, or through the hole in the swaged terminal at either end of the turnbuckle assembly. Spiral each of the wire ends in opposite directions around the first half of the turnbuckle barrel, so as to cross each other twice. Thread both wire ends through the hole in the middle of the barrel so that the third crossing of wire ends is in the hole, again, spiral the two wire ends in opposite directions around the remaining half of the turnbuckle, crossing them twice. Then, pass one wire end through the cable eye or fork, or through the hole in the swaged terminals, in the manner previously described. Wrap both wire ends around the shank for at least four turns each, cutting off excess wire. This method is shown in figure 7-26(C).

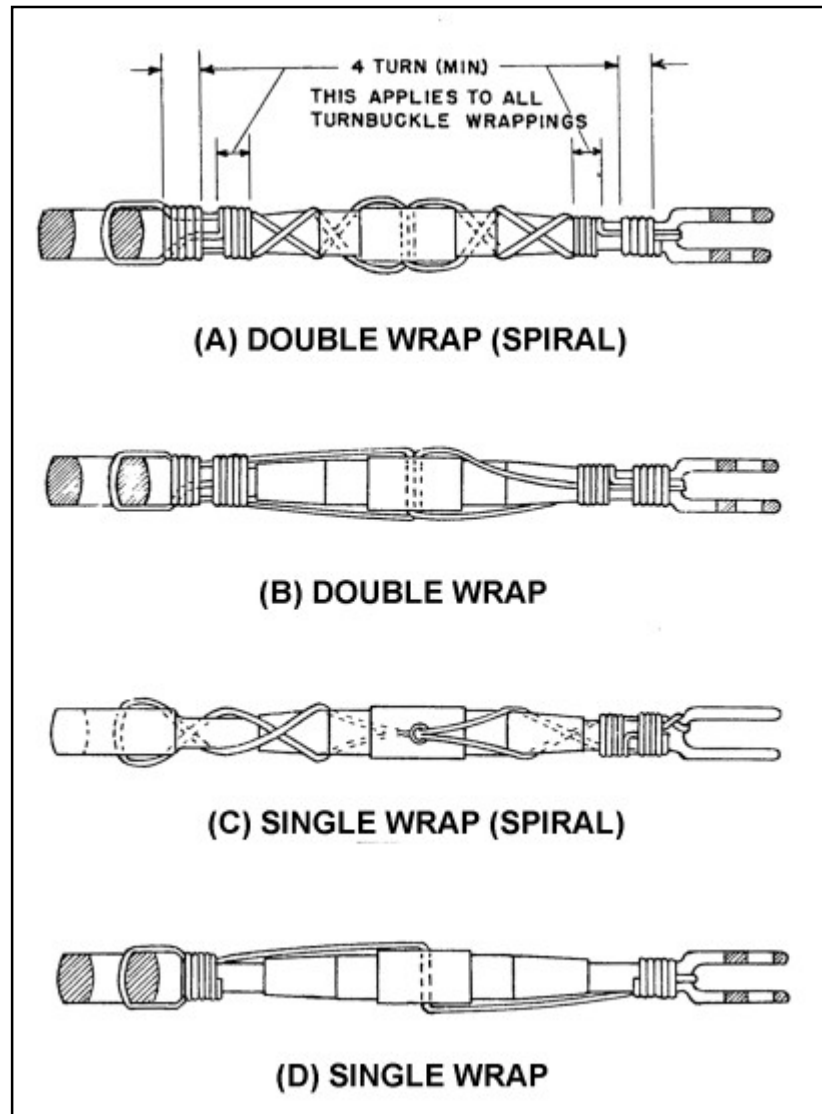

FIGURE 7-26. Safelying turnbuckles.

b. For the method shown in figure 7-26D, pass one length of wire through the center hole of the turnbuckle and bend the wire ends toward opposite ends of the turnbuckle. Then pass each wire end through the cable eye or fork, or through the hole in the swaged terminal, and wrap each wire around the shank for at least four turns, cutting off excess wire. After safelying, no more than three threads of the turnbuckle threaded terminal should be exposed.

7-182. SAFETY-WIRE SECURED TURNBUCKLES. (See figure 7-27.) Before securing turnbuckles, threaded terminals

should be screwed into the turnbuckle barrel until no more than three threads of either terminal are outside the barrel. After the turnbuckle has been adjusted for proper cable tension, two pieces of safety wire are inserted, half the wire length into the hole in the center of the turnbuckle barrel. The safety-wires are bent so that each wire extends half the length of the turnbuckle on top and half on bottom. The ends of the wires are passed through the hole in the turnbuckle eyes or between the jaws of the turnbuckle fork, as applicable. The wires are then bent toward the center of the turnbuckle and each wire is wrapped around

the shank four times, binding the wrapping wires in place as shown in figure 7-27.

a. When a swaged terminal is being secured, one wire is passed through the hole in the terminal and is looped over the free end of the other wire and both ends wrapped around the shank. All lock wire used in the safetying of turnbuckles should be carbon steel, corrosion-resistant steel, nickel-chromium iron alloy (inconel), nickel-copper alloy (monel) or aluminum alloy. For safety cable diameter of safety wire size and material, refer to table 7-8.

b. Care should be exercised when safety wiring, particularly where corrosion will present a problem, because smaller wire sizes tend to crack when twisted.

TABLE 7-8. Turnbuckle safetying guide.

Cable Size	Type of Wrap	Diameter of Safety Wire	Material (Annealed Condition)
1/16	Single	0.040	Copper, brass. ¹
3/32	Single	0.040	Copper, brass. ¹
1/8	Single	0.040	Stainless steel, Monel and "K" Monel.
1/8	Double	0.040	Copper, brass. ¹
1/8	Single	0.057 min.	Copper, brass. ¹
5/32 and greater.	Double	0.040	Stainless steel, Monel and "K" Monel. ¹
5/32 and greater	Single	0.057 min.	Stainless steel, Monel or "K" Monel. ¹
5/32 and greater	Double	0.0512	Copper, brass.

¹Galvanized or tinned steel, or soft iron wires are also acceptable.

7-183. SPECIAL LOCKING DEVICES. Several turnbuckle locking devices are available for securing turnbuckle barrels such as wire-locking clips. Persons intending to use a special device must ensure the turnbuckle assembly has been designed to accommodate such devices. A typical unit is shown in figure 7-28. When special locking devices are not readily available, the use of safety wire is acceptable.

7-184. ASSEMBLING AND SECURING CLIP-LOCKING TURNBUCKLES. (See table 7-9 and figure 7-29.) Wire clip-locking turnbuckles are assembled and secured in the following ways.

a. Engage threads of turnbuckle barrel with threads of cable terminal and turn barrel until proper cable tension is reached.

b. Align slot in barrel with slot in cable terminal.

c. Hold lock clip between thumb and forefinger at loop end and insert straight end of clip into opening formed by aligned slots.

d. Bring hook end of lock clip over hole in center of turnbuckle barrel and seat hook loop into hole.

e. Apply pressure to hook shoulder to engage hook lip in turnbuckle barrel and to complete safety locking of one end of turnbuckle.

NOTE: Repeat the above steps to safety lock the opposite end of turnbuckle. Both lock clips may be inserted in the same turnbuckle barrel hole or they may be inserted in opposite holes. However, do not reverse wire locking clips

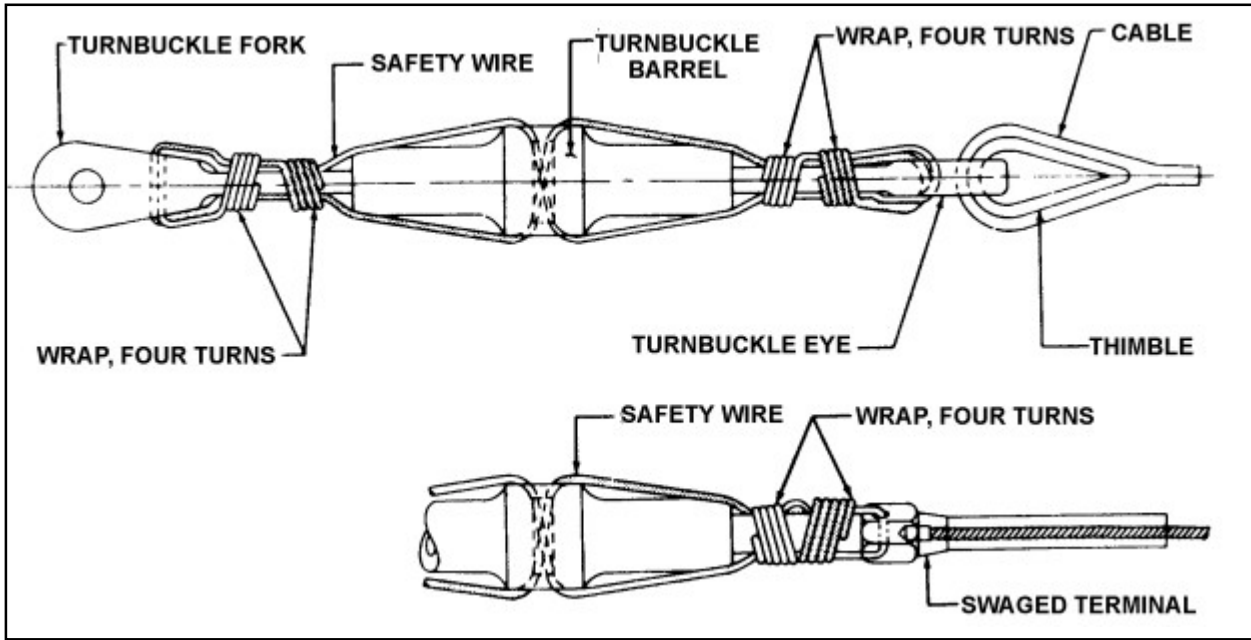

FIGURE 7-27. Securing turnbuckles.

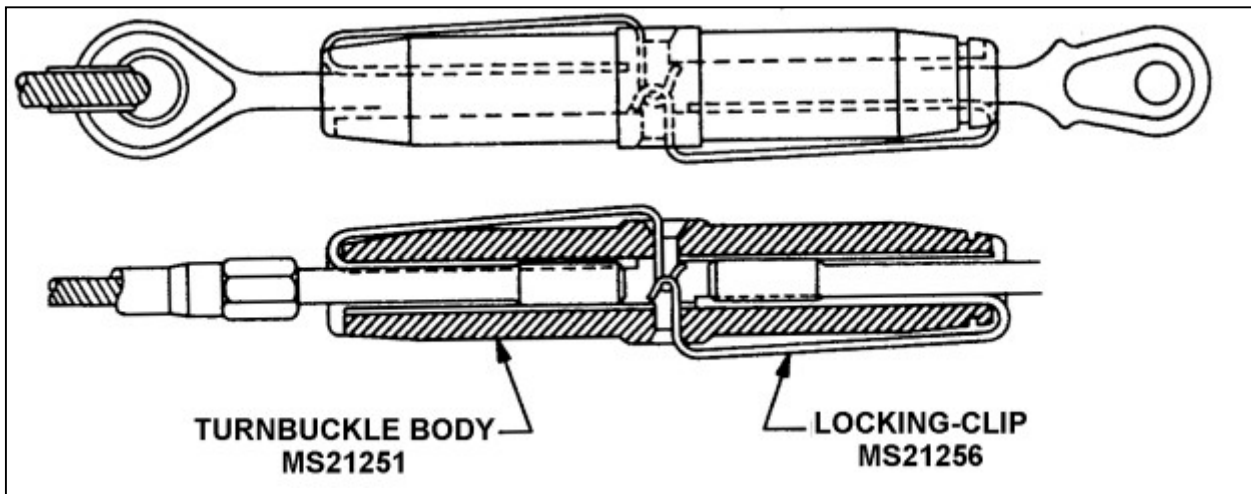

FIGURE 7-28. Clip-type locking device.

TABLE 7-9. Locking-clip application.

NOMINAL CABLE DIA.	THREAD UNF-3	LOCKING CLIP MS21256	TURNBUCKLE BODY MS21251
1/16	No. 6-40	-1	-2S
3/32	No. 10-32		-3S
		-2	-3L
1/8	1/4-28	-1	-4S
		-2	-4L
5/32		-1	-5S
		-2	-5L
3/16	5/16-24	-1	-6S
			-6L
7/32	3/8-24	-2	-7L
1/4			-8L
9/32	7/16-20	-3	-9L
5/16	1/2-20		-10L

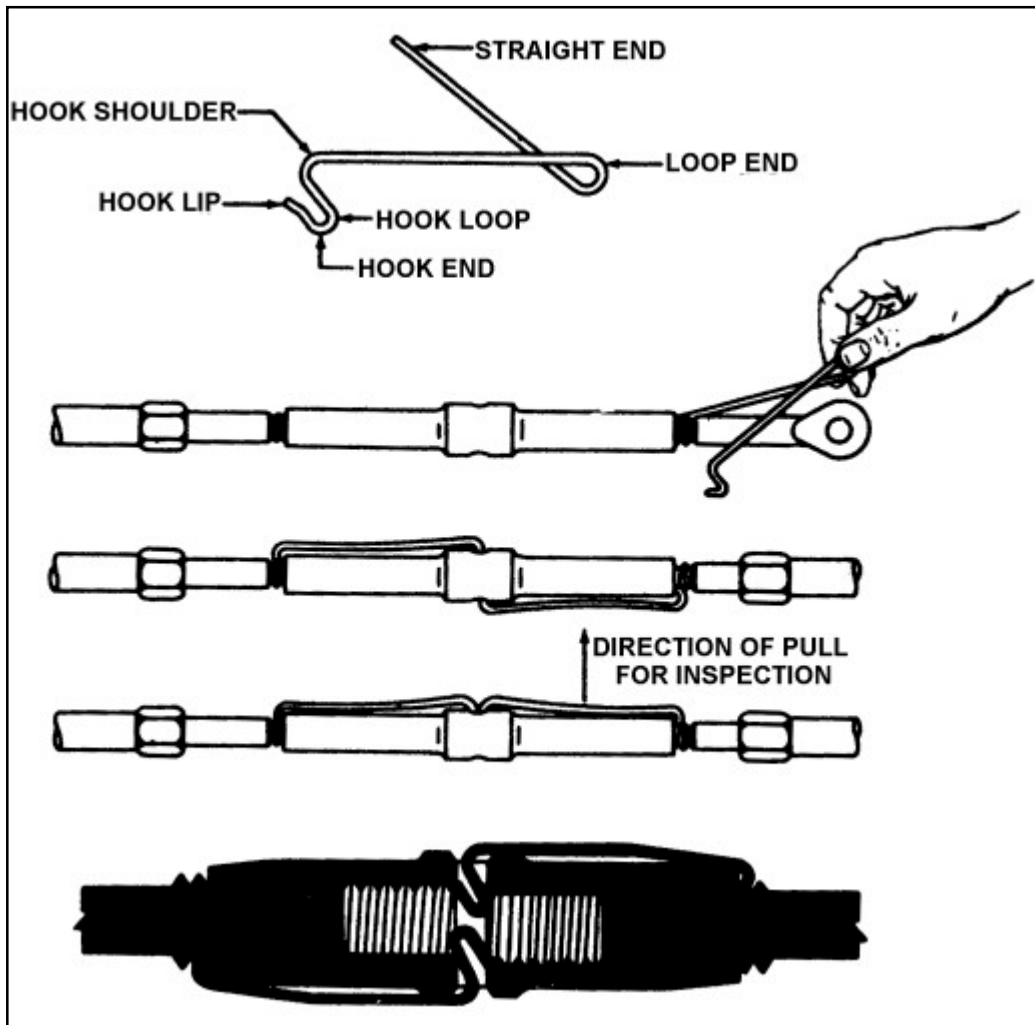

FIGURE 7-27. Assembling and securing clip-locking turnbuckles

7-185.—7-195. [RESERVED.]

SECTION 11. HARDWARE IDENTIFICATION TABLES

TABLE 7-10. TABLE OF RIVETS.







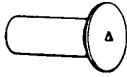
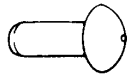

Rivet Number	Description
AN427 	Rivet, 100° csk. Head steel, monel, copper
AN430 	Rivet, round head al. Alloy
AN441 	Rivet, tinnerns Head, steel, ss, monel
AN456 	Rivet, brazier head, aluminum alloy
AN123151-123750 	Rivet, universal head & 100° steel, Inconel
NAS 1200 	Rivet, solid, 100° flush shear head
NAS 1241 	Rivet, solid, 100° flush head
NAS 1242 	Rivet, solid universal head
NAS 1398 	Rivet, blind, protruding head, locked spindle
NAS 1399 	Rivet, blind, 100° csk. Head, locked spindle

TABLE 7-10. (CONTINUED)



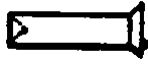
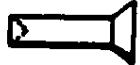

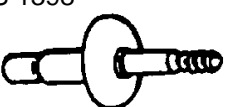

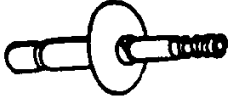
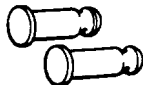
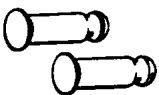

Rivet Number	Description
NAS 1738-1739 	Rivet, blind, protruding & flush hd., mech. locked spindle, bulbed
NAS1806-1816 	Rivet, hi-shear, flathead., ti. alloy
NAS1906-1916 	Rivet, hi-shear, 100° hd., ti. alloy
AN124951-125550 	Rivet, solid universal head & 100° csk. head, cres. steel, inconel
AN125551-1255700 	Rivet, solid universal head, steel
AN426 MS20426 	Rivet, solid, csk. 100° head al. alloy
AN470 MS20470 	Rivet, solid, universal head, al. & al. alloy
MS9319 	Rivet, solid univ. head, AMS 7233
MS9403 	Rivet, solid, universal head, AMS 5737
MS16535 	Rivet, tubular, oval head

TABLE 7-10. (CONTINUED)



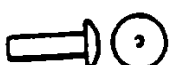



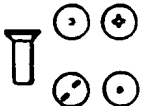

Rivet Number	Description
MS16536 	Rivet, tubular, 100° flat csk. head
MS20426 	Rivet, solid, csk., 100° al. alloy
MS20427 	Rivet, solid, csk., 100° flush hd., AMS 7233
MS20470 	Rivet, solid, universal head, al. alloy
MS20600 	Rivet, blind, pull stem, protruding head
MS20601 	Rivet, blind, pull stem, 100°, flush head
MS20602-20603 	Rivet, blind, explosive
MS20604-20605 	Rivet, blind nonstructural univ. and 100° flush head
MS20613-20615 	Rivet, solid, monel, universal hd., steel, ss, brass, copper
NAS452-453 	Rivnut, 100° csk. head & flathead
NAS454-455 	Rivet blind, al. alloy

TABLE 7-10. (CONTINUED)

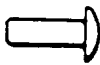
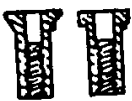

Rivet Number	Description
NAS508 	Rivet, universal head, monel
NAS1054 	Rivet, hi-shear, protruding head
NAS1055 	Rivet, hi-shear, 100° flush head
NAS1097 	Rivet, solid, 100° flush shear head, al. Alloy
NAS1198 	Rivet, solid, universal head
NAS1199 	Rivet, solid, 100° flush head

TABLE 7-11. TABLE OF SCREWS.



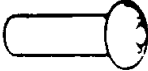
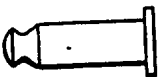
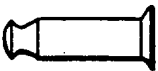

Screw MS, AN, or NAS Number	Description
AN255 	Screw, external relieved body
AN500 & 501 	Screw, machine fillister head
AN502 & 503 	Screw, machine, fill. Head, drilled, coarse & fine
AN504 	Screw, tapping, thread cutting rnd. Head, mach. Thread

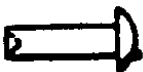
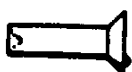
TABLE 7-11. (CONTINUED)











Screw MS, AN, or NAS Number	Description
AN505 	Screw, machine, flathead, 82° coarse thread
AN506 	Screw, tapping, type F, coarse & fine
AN507 	Screw, machine, flathead, 100°
AN508 	Screw, machine, round head
AN509 	Screw machine, 100° structural
AN510 	Screw, machine, flathead, 82° fine thread
AN515 & AN520 	Screw, machine, round head
AN525 	Screw, washer head
AN526 	Screw, machine buttonhead
AN530 	Screw-tapping, thread cutting, rnd. hd.
AN531 	Screw, tapping, thread forming or cutting, 82° flathead.

TABLE 7-11. (CONTINUED)











Screw MS, AN, or NAS Number	Description
AN535 	Drive screw, round head
AN545 	Screw, wood, round head
AN550 	Screw, wood, flathead, 82°
AN565 	Setscrew, hex. & fluted socket
AN115401-115600 	Screws, flat fill. head, steel, .190-.375
AN115601-115800 	Drilled shank Screw flat fill. head, steel, .190-.375
AN115801-116150 	Screw, flat fill. head, steel. .190-.375
AN116901-117080 	Screw, oval fill. head, steel
MS9016 	Bushing Screw, plain
MS9017 	Bushing Screw, slotted
MS9122-9123 	Screw, machine slotted hex. hd.

TABLE 7-11. (CONTINUED)











Screw MS, AN, or NAS Number	Description
MS9177-9178 	Screw, dbl. hex. head, cres.
MS9183-9186 	Screw, machine, steel, drilled 12 pt. hd., cad. plate
MS9187-9188 	Screw, drilled dbl. hex. head, cres.
MS9189-9192 	Screw, machine, steel, 12 pt. hd., black oxide
MS9206-9214 	Screw, dbl. hex. ext. washer head, diffused nickel cad. plate
MS9215-9223 	Screw, dbl. hex. ext. washer head, diffused nickel cad. plate, drilled
MS9281-9291 	Screw, machine, hex. hd., AMS 6322 black oxide
MS9292-9302 	Screw, machine, hex. hd., AMS 6322 blk. oxide, drilled
MS9316-9317 	Screw, machine, steel slotted hex. head
MS9438-9439 	Screw, mach. steel AMS 6304 diffused nickel cad. hex. hd., one hole
MS9631-9639 	Screw, mach., hex. hd. one hole, full shank, titanium AMS 4967

TABLE 7-11. (CONTINUED)











Screw MS, AN, or NAS Number	Description
MS16198 	Screw, wood, slotted RH austenitic corr. res. steel
MS16199 	Screw, wood, slot flat-head, copper silicone
MS16995 	Screw, cap, socket head hex., corr. resisting steel UNC-3A
MS16996 	Screw, cap, socket head, hex., corr. resisting steel UNF-3A
MS16997 	Screw, cap, socket head, hex., alloy steel cad. UNC-3A
MS16998 	Screw, cap, socket head, hex., alloy steel, cad. UNF-3A
MS18063-18068 	Setscrew, self-locking, cup, flat, cone pts., steel & stainless
MS18211 	Screw, machine, flat-head, plastic, nylon
MS18212 	Screw, machine, pan-head, plastic, nylon
MS21090 	Screw, self-lock, pan-head, cross recessed
MS21207 	Screw, tapping, 100° clk. flathead., steel, cres. steel

TABLE 7-11. (CONTINUED)











Screw MS, AN, or NAS Number	Description
MS21262 	Screw, self-lock, int. wrenching
MS21277-21285 	Screw, machine, double hex., ext. washer head
MS21286-21294 	Screw, machine, double hex., ext. washer head
MS21295 	Screw, self-lock, int. wrenching
MS21318 	Screw, drive, round head, Type U
MS21342 	Setscrew, fluted socket, cup and flat point
MS24615-24618 	Screw, tapping, phillips recessed, pan & 82° flathead Type A
MS24619-24622 	Screw, tapping, phillips recessed, pan & 82° flathead Type B
MS24623-24626 	Screw, tapping, cross recessed pan & 82° flathead, Type BF or BT
MS24627-24630 	Screw, tapping, thread cutting cross recessed pan & 82° flathead, Type F
MS24667 & 24671 	Screw, cap socket hd., flat, csk.

TABLE 7-11. (CONTINUED)









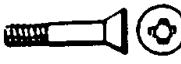

Screw MS, AN, or NAS Number	Description
MS24673-24678 	Screw, cap socket hd., flat, drilled
MS24693 	Screw, machine, flat csk. head, 100° cross recess
MS24694 	Screw, machine, csk. flathead., 100° cross recess, structural
MS27039 	Screw, machine, panhead, structural, cross recessed
MS35190-35203 	Screw, machine 82° flathead., cross recessed, steel, brass, alum.
MS35206-35219 	Screw, machine, panhead, cross recessed, steel, brass, alum.
MS35223-35234 	Screw, machine, panhead, slotted, SS steel, steel
MS35239-35243 	Screw, machine, flathead., slotted, steel
MS35265-35278 	Screw, machine, drilled fillister head, slotted, SS steel, brass, alum.
MS35492-35493 	Screw, wood, flathead, cross recessed
MS35494-35495 	Screw, wood, flat & round hd., slotted

TABLE 7-11. (CONTINUED)











Screw MS, AN, or NAS Number	Description
MS35914 	Insert, screw, thread, self-tapping
MS51017-51047 	Setscrew, hex. socket SS & steel half dog, cone, flat, cup pt.
MS51861 	Screw, tapping, type AB, panhead, cross recessed
MS51862 	Screw, tapping, type AB, flathead., cross recessed
MS51957-51958 	Screw, machine, panhead, cross recessed
MS51959-51960 	Screw, machine, flathead, cross recessed
MS51963-51966 	Setscrew, hex. socket, cup & flat point
MS51973-51974 	Setscrew, hex. socket, cone point
MS51975 	Screw, shoulder, socket head
MS51976-51977 	Setscrew, hex. socket, half dog point
MS51981-51982 	Setscrew, hex. socket, oval point

TABLE 7-11. (CONTINUED)







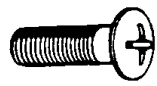

Screw MS, AN, or NAS Number	Description
NAS220-237 	Screw, brazier hd. phil-lips recessed
NAS384-385 	Screw, oval head, phil-lips recessed 100°, 82°, steel
NAS387-388 	Screw, machine, oval hd., 100°, 82°, steel
NAS514 	Screw, machine, 100° flathead., fully threaded, al. steel
NAS517 	Screw, 100° flathead, close tol. 160,000 psi
NAS548 	Screw, 100° flathead, type B tapping
NAS560 	Screw, machine, 100° structural, hi-temp
NAS600-606 	Screw, machine, air-craft, panhead phil-lips recessed, full thr., steel
NAS608-609 	Screw, hex. socket cap, plain & self-locking, drilled head
NAS623 	Screw, panhead. thr. short, 160,000 psi
NAS720 	Screw, panhead, as-sembled

TABLE 7-11. (CONTINUED)

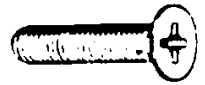
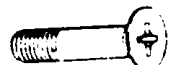





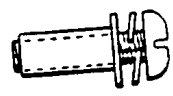



Screw MS, AN, or NAS Number	Description
NAS1081 	Setscrew, hex. socket, self-locking
NAS1096 	Screw, hex. head, recess, full thr.
NAS1100 	Screw, machine, panhead, full thread, torq.-set
NAS1101 	Screw, machine, flat fill hd. full thread
NAS1102 	Screw, machine, 100° flathead. full thr. torq.-set
NAS1121-1128 	Screw, machine, flat fill hd., short thread, torq.-set
NAS1131-1138 	Screw, machine, pan hd., short thread, torq.-set
NAS1141-1148 	Screw, machine, panhead. modified, short thread torq.-set
NAS1151-1158 	Screw, machine, 100° flathead., sort thread, torq.-set
NAS1161-1168 	Screw, machine, 100° flathead., shear, torq.-set
NAS1171-1178 	Screw, panhead., shear, self-lock., torq.-set

TABLE 7-11. (CONTINUED)





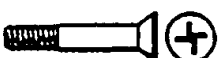





Screw MS, AN, or NAS Number	Description
NAS1181-1188 	Screw, flat fill hd., self-locking, torq.-set
NAS1189 	Screw, flat 100° hd., full thread, self-locking
NAS1190 	Screw, panhead., self-locking, full thread
NAS1191 	Screw, flat fill. hd., full thread, self-locking
NAS1216 	Screw, panhead hi-torque, full thread
NAS1217 	Screw, panhead, hi-torque, short thread
NAS1218 	Screw, panhead, hi-torque, short thread
NAS1219 	Screw, 100° csk. hd., hi-torque, full thread
NAS1220 	Screw, 100° csk. hd., hi-torque, short thread
NAS1221 	Screw, 100° clk. hd., hi-torque, long thread
NAS1298 	Screw, shoulder, brazier head

TABLE 7-11. (CONTINUED)





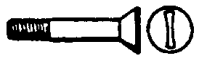

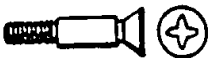
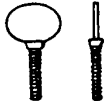
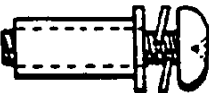

Screw MS, AN, or NAS Number	Description
NAS1299 	Screw, shoulder, 100° flathead
NAS1300 	Thumbscrew, drilled/undrilled
NAS1301 	Screw, panhead, assembled washers Phillips recess
NAS1351-1352 	Socket Capscrew, hex. head, drilled/undrilled
NAS1393 	Screw, 82° flathead, torq-set
NAS1402-1406 	Screw, panhead, Phillips recess
NAS1579 	Screw, panhead., full thread, 1200° F
NAS1603-1610 	Screw, flush head, .0312 O.S.
NAS1620-1628 	Screw, machine, 100° flat short thread, torq-set
NAS1630-1634 	Screw, machine, panhead., short thread, torq.-set
NAS1635 	Screw, panhead cross recessed, full thread

TABLE 7-11. (CONTINUED)











Screw MS, AN, or NAS Number	Description
NAS5000-5006 	Screw, panhead, tri-wing recess, short thr., alloy stl.
NAS5100-5106 	Screw, panhead, tri-wing recess, short thr., cres.
NAS5200-5206 	Screw, panhead, tri-wing recess, short thr., cres.
NAS5300-5306 	Screw, fillister head, tri-wing recess, full thr., alloy stl.
NAS5400-5406 	Screw, fillister hd., tri-wing recess, full thr., cres.
NAS5500-5506 	Screw, fillister hd., tri-wing recess, full thr., titanium
NAS5600-5606 	Screw, 100° head, tri-wing recess, full thr., alloy stl.
NAS5700-5706 	Screw, 100° head, tri-wing recess, full thr., cres.
NAS5800-5806 	Screw, 100° head, tri-wing recess, full thr., titanium
NAS5900-5903 	Screw, hex. Head, tri-wing recess, full thr., alloy stl.
NAS6000-6003 	Screw, hex. Head, tri-wing recess, full thr., cres.

TABLE 7-11. (CONTINUED)



Screw MS, AN, or NAS Number	Description
NAS6100-6103 	Screw, hex head, tri-wing recess, full thr., titanium
NAS6500-6506 	Screw, 100° oval hd., tri-wing recess, full thr., cres.
NAS6900-6904 	Screw, panhead, tri-wing recess, full thr., cres.

TABLE 7-12. TABLE OF BOLTS.





Bolt Number	Description
AN3-20 	Bolt, machine
AN21-36 	Bolt, clevis
AN42-49 	Bolt, eye
AN73-81 	Bolt, machine, drilled
AN173-186 	Bolt, aircraft Close tolerance
AN774 	Bolt, flared tube
AN775 	Bolt, universal fitting

TABLE 7-12. (CONTINUED)





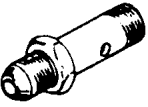
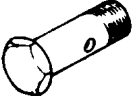

Bolt Number	Description
AN148551-149350 	Bolt, socket head, 6-hole drilled, .190-.625
AN101001-101900 	Bolt, hex, steel, head
AN101901-102800 	Bolt, hex., drilled shank, steel
AN102801-103700 	Bolt. Drilled hex. Head, (one hole), steel
AN103701-104600 	Bolt, drilled hex. Head, steel, (six holes)
AN104601-105500 	Bolt, hex. Head, corrosion-resistant steel
AN105501-106400 	Bolt, hex. Head, drilled shank, corrosion-resistant steel
AN106401-107300 	Bolt, hex., drilled head, (one holes), corrosion-resistant steel
AN107301-108200 	Bolt, hex., drilled head, (six holes), corrosion-resistant steel
MS9033-9039 	Bolt, machine 12pt. Head, 130,000 psi min. T.S.
MS9060-9066 	Bolt, machine 12pt. Double hex. 130,000 psi min. T.S. ext. washer head, drilled

TABLE 7-12. (CONTINUED)

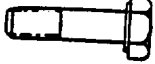
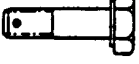
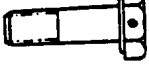

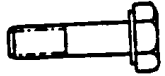

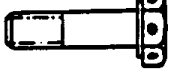
Bolt Number	Description
MS9088-9094 	Bolt, machine, steel, drilled 12 pt. head
MS9110-9113 	Bolt, machine, double hex., ext. washer head, close tolerance
MS9146-9152 	Bolt, steel, 12 pt. hd. black oxide 125,000 psi min. T.S.
MS9157-9163 	Bolt, steel, 12pt. hd. black oxide 125,000 psi min. T.S.
MS9169-9175 	Bolt, steel, 12 pt. drilled hd., black oxide 125,000 psi min. T.S.
MS9224 	Bolt, 12 pt. head, heat resistant
MS9397-9402 	Bolt, tee head, AMS 6322, chamfered cad. pl.
MS9432-9437 	Bolt, tee head AMS 5735 chamfered
MS9440-9448 	Bolt, mach. steel. AMS 6304 diffused nickel cad. hex. hd., 3 holes
MS9449-9459 	Bolt, mach. steel, AMS 6304 diffused nickel cad., hex. head
MS9487-9497 	Bolt, mach. hex. hd. full shank, AMS 5731

TABLE 7-12. (CONTINUED)



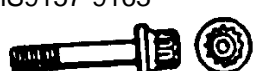
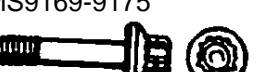

Bolt Number	Description
MS9498-9508 	Bolt, mach. hex. hd., 1 hole, full shank
MS9516-9526 	Bolt, mach., steel AMS 6322 cad. 1 hole hex. hd.
MS9527-9537 	Bolt, mach., steel AMS 6322 cad. 1 hole hex. hd.
MS9554-9562 	Bolt, mach., dbl. hex. ext. wash. hd., PD shank, AMS 5731
MS9563-9571 	Bolt, mach., dbl. hex. ext. wash. hd. drilled, AMS 5731
MS9572-9580 	Bolt, mach., dbl. hex. ext. wash. hd., drilled, PD shank AMS 5731 silver plated
MS9583-9591 	Bolt, mach., hex. hd. 6 holes full shank, AMS 5731
MS9622-9630 	Bolt, mach., hex. hd. 1 hole, PD shank, titanium AMS 4967
MS9641-9648 	Bolt, mach., hex. hd., 1 hole, full shank titanium AMS 4967
MS9649-9652 	Bolt, mach., hex. hd. full shank, titanium AMS 4967
MS9676-9679 	Bolt, mach., dbl. hex. ext. wash. hd., cup washer locked, cres. AMS 5731

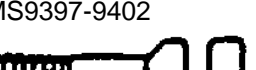
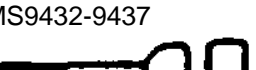
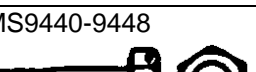
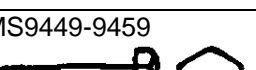
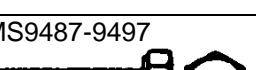
TABLE 7-12. (CONTINUED)

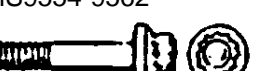
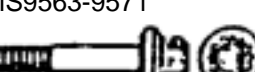
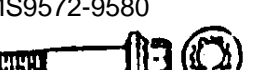

Bolt Number	Description
MS9680-9683 	Bolt, mach., dbl. hex. ext. wash. hd., cup washer locked, steel AMS 6322 cad.
MS9685-9693 	Bolt, mach., hex. hd. 1 hole, PD shank, steel AMS 6304 diffused nickel cad.
MS9694-9702 	Bolt mach. dbl. hex. ext. wash. hd. AMS 5708
MS9703-9711 	Bolt, mach., dbl. hex. ext. wash. hd., drilled, AMS 5708
MS9712-9720 	Bolt, mach. dbl. hex. ext. wash. hd. drilled, AMS 5708 silver plate
MS9730-9738 	Bolt, mach., dbl. hex. ext. wash. hd. PD shank, cres. AMS 5643
MS9739-9747 	Bolt, mach. dbl. hex. est. wash, hd. drilled, PD shank, cres. AMS 5643
MS9748-9756 	Bolt, mach. dbl. hex. ext. wash. hd. PD shank, titanium AMS 4967
MS9757-9765 	Bolt, mach., dbl. hex. ext. wash. hd., PD shank, drilled, titanium AMS 4967
MS9781-9791 	Bolt, hex. hd., mach. full shank, AMS 5643
MS9792-9802 	Bolt, mach., hex. hd. 1 hole, full shank, AMS 5643

TABLE 7-12. (CONTINUED)

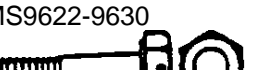
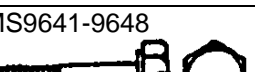
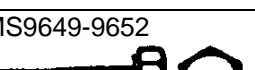
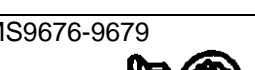

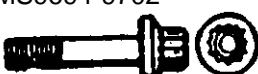
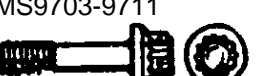
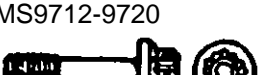
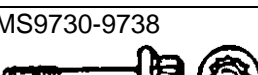
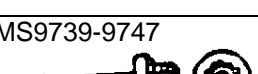
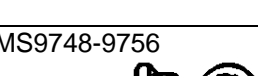
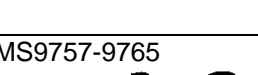
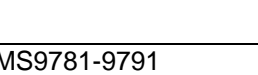
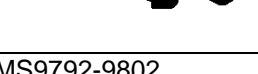

Bolt Number	Description
MS9803-9813 	Bolt, mach., hex. Hd. 1 hole, full shank, AMS 5643
MS9814-9824 	Bolt, mach., hex. Hd. 1 hole, PD shank, AMS 5643
MS9883-9891 	Bolt, mach., dbl. Hex. Ext. wash. Hd., AMS 5616
MS9892-9900 	Bolt mach., dbl. Hex. Ext. wash. Hd., AMS 5616 drilled
MS9912-9920 	Bolt, mach., dbl. Hex. Ext. wash. Hd., PD shank, steel AMS 6322 cad.
MS9921-9929 	Bolt, mach., dbl. Hex. Ext. wash hd. PD shank, steel AMS 6322 cad. Drilled
MS9930-9938 	Bolt, mach., dbl. Hex. Ext. wash. Hd., full shank, steel AMS 6322 cad.
MS9939-9946 	Bolt, mach., dbl. Hex. Ext. wash. Hd., drilled, full shank, steel AMS 6322 cad.
MS20004-20024 	Bolt, int. wrench, 160 KSI
MS20033-20046 	Bolt, machine, hex. Head, 1200 °F
MS20073-20074 	Bolt, machine, aircraft, drilled hd., fine & coarse thr.

TABLE 7-12. (CONTINUED)





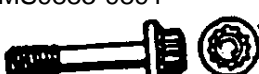
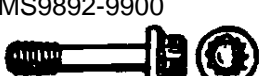
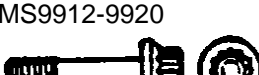
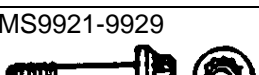
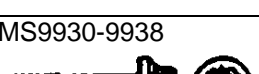
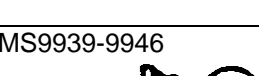
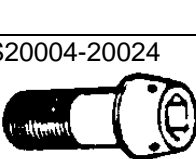





Bolt Number	Description
MS21091-21093 	Bolt, self-lock., 100° flush head, cross recessed
MS21094-21095 	Bolt, self-lock., hex. head
MS21096-21097 	Bolt, self-lock., pan-head, cross recessed
MS21098-21099 	Bolt, self-lock., 12 pt. ext. wrenching
MS21250 	Bolt, 12 pt., ext. wrenching
NAS144-158 	Bolt, internal wrenching, steel, 1/4-28 thru 1-1/8-12
NAS333-340 	Bolt, 100°, close tolerance, hi-strength
NAS428 	Bolt, adjusting, crowned hex. hd.
NAS464 	Bolt, shear, close tolerance
NAS501 	Bolt, hex. head, drilled & undrilled
NAS551 	Bolt, universal fitting

TABLE 7-12. (CONTINUED)

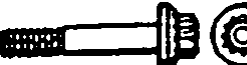

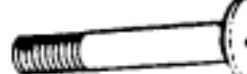





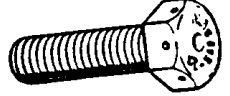

Bolt Number	Description
NAS563-572 	Bolt, full thread, fully identified head
NAS583-590 	Bolt, 100° head, hi-torque, close tol. 160,000 psi
NAS624-644 	Bolt, twelve point external wrench, 180000 psi
NAS653-658 	Bolt, hex. head, close tolerance, ti. alloy
NAS663-668 	Bolt, full thread, fully identified head
NAS673-678 	Bolt, hex. head, close tolerance, ti. alloy
NAS1003-1020 	Bolt, machine, hex. head
NAS1053 	Eye Bolt Assembly, Shoulder nut
NAS1083 	Bolt, 100° flathead, titanium alloy
NAS1103-1120 	Bolt, machine, hex. head
NAS1202-1210 	Bolt, 100° phil. recessed, close tolerance, 16,000 psi

TABLE 7-12. (CONTINUED)



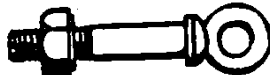







Bolt Number	Description
NAS1223-1235 	Bolt, self-locking, hex. head 250 °F
NAS1236 	Bolt, universal, Tube-end, flareless
NAS1243-1250 	Bolt, 100° head, hi-torq. 1600 psi
NAS1253-1260 	Bolt, 100° head, flush hd., .0312 O.S. hi-torque
NAS1261-1270 	Bolt, hex. head, short thread
NAS1271-1280 	Bolt, 12 point hd., external wrenching
NAS1297 	Bolt, shoulder, hex. head
NAS1303-1320 	Bolt, hex. head, close tolerance, 160,000 psi
NAS1414-1422 	Lock bolt, shear 100° head, all. steel
NAS1424-1432 	Lock bolt, shear protruding head, steel
NAS1503-1510 	Bolt, 100° flush head, hi-torq.

TABLE 7-12. (CONTINUED)







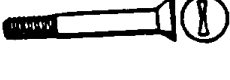



Bolt Number	Description
NAS1516-1522 	Lock Bolt, 100° head, pull type, al. Alloy
NAS1578 	Bolt, shear panhead, 1200 °F
NAS1580 	Bolt, tension, flush hd., 1200 °F
NAS1581 	Bolt, shear reduced 100 °F flush head, 1200 °F
NAS1586 	Bolt-tension, 1200 °F, 12 point, external wrenching
NAS1588 	Bolt, tension, flush hd., 1200 °F
NAS1703-1710 	Bolt, 100° head, .0156 O.S. shank,
NAS2005-2012 	Bolt lock, protruding head, ti. Alloy
NAS2105-2112 	Bolt, lock, 100° head, ti. Alloy
NAS2206-2210 	Bolt, lock, stump type, protruding head, ti. Alloy
NAS2306-2310 	Bolt, lock, stump type, 100° head, ti. Alloy

TABLE 7-12. (CONTINUED)











Bolt Number	Description
NAS2406-2412 	Bolt, lock, shear protruding head, ti. alloy
NAS2506-2512 	Bolt, lock, 100° head, ti. alloy
NAS2606-2612 	Bolt, lock, shear protruding head, ti. alloy
NAS2706-2712 	Bolt, lock, shear 100° head, ti. alloy
NAS2803-2810 	Bolt, lock, 100° hd., torq-set 180,000 psi
NAS2903-2920 	Bolt, hex. head, .0156 O.S. shank, 160,000 psi
NAS3003-3020 	Bolt, hex. head, .0312 O.S. shank, 160,000 psi
NAS3103-3110 	Bolt, U type
NAS3203-3210 	Bolt, hook
NAS3303-3305 	Bolt, U strap type
NAS4104-4116 	Bolt, 100° head, tri-wing recess, long thr., alloy stl.

TABLE 7-12. (CONTINUED)











Bolt Number	Description
NAS4204-4216 	Bolt, 100° head, tri-wing recess, long thr., cres.
NAS4304-4316 	Bolt, 100° head, tri-wing recess, long thr., titanium
NAS4400-4416 	Bolt, 100° head, tri-wing recess, short thr., alloy stl.
NAS4500-4516 	Bolt, 100° head, tri-wing recess, short thr., cres.
NAS4600-4616 	Bolt, 100° head, tri-wing recess, short thr., titanium
NAS4703-4716 	Bolt, 100° reduced, tri-wing recess, short thr., alloy stl.
NAS4803-4816 	Bolt, 100° reduced, tri-wing recess, short thr., cres.
NAS4903-4916 	Bolt, 100° reduced, tri-wing recess, short thr., titanium
NAS6203-6220 	Bolt, hex. head, short thread, alloy steel
NAS6303-6320 	Bolt, hex. head, short thread, cres.
NAS6403-6420 	Bolt, hex. head, short thread, titanium

TABLE 7-12. (CONTINUED)



Bolt Number	Description
NAS6604-6620 	Bolt, hex head, long thread, alloy steel
NAS6704-6720 	Bolt, hex. head, long thread, cres.

TABLE 7-13. (CONTINUED)











Nut Part Number	Description
AN345 	Nut, plain, hex., n-s, fine thread
AN350 	Nut, plain, wing
AN355 	Nut, engine, slotted
AN356 	Nut, stamped
AN360 	Nut, plain, engine
AN361 	Self-locking nut plate, countersunk 100°, 550 °F.
AN362 	Nut, plate, self-locking, noncounters., 550°F.
AN363 	Nut, self-locking, 550 °F.
AN364 	Nut, self-locking, thin, 250 °F.
AN365 	Nut, self-locking 250°F.
AN366 	Nut, plate, noncounters., 250°F.

TABLE 7-13. TABLE OF NUTS.







Nut Part Number	Description
AN256 	Nut, self-lock right angle plate
AN310 	Nuts, castellated
AN315 	Nut, plain
AN316 	Nut, check
AN320 	Nut, castle shear
AN335 	Nut, plain, hex, nonstructural
AN340 	Nut, plain, hex., n-s, course thread
AN341 	Nut, plain, hex.

TABLE 7-13. (CONTINUED)

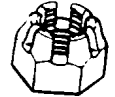







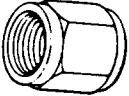

Nut Part Number	Description
AN373 	Countersunk nut, plate 100°, 250°F.
AN805 	Nut, union
AN817 	Nut, coupling
AN818 	Nut, coupling
AN924 	Nut, flared tube
AN3054 	Nut, coupling, elec. conduit
AN3066 	Nut, plain, hex. conduit coupling
AN6289 	Nut, flared tube universal fitting
AN121501-121550 	Nut, plain or cres. steel
AN121551-121600 	Nut, castel., hex.
MS9099-9100 	Nut, hex., boss connection, aluminum & cres.

TABLE 7-13. (CONTINUED)



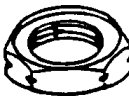







Nut Part Number	Description
MS9197-9199 	Nut, tube coupling
MS9200-9201 	Nut, plain, hex., boss connection
MS9356-9357 	Nut, plain hex., A-286
MS9358-9359 	Nut, castellated hex., A-286
MS9360 	Nut, plain hex. Drilled, A-286
MS9361-9362 	Nut, plain hex. Check, A-286
MS9363-9364 	Nut, slotted hex. Shear hd., A-286
MS9553 	Nut, hex. Boss connection, cres.
MS9766-9767 	Nut, dbl. Hex. Cup washer locked, AMS 5737 cres. And AMS 6322 cad.
MS9881 	Nut, plain, hex. AMS 6322, cad. Plate
MS9882 	Nut, plain, hex., drilled, AMS 6322, cad. Plate

TABLE 7-13. (CONTINUED)











Nut Part Number	Description
MS9951 	Nut, spanner, end slots, cup washer locked, AMS 6322
MS16203 	Nut, plain, hex. Nonmagnetic
MS17825-17826 	Nut, self-locking, castle, hex. Regular and thin
MS17828 	Nut, self-locking, nylon insert, 250°, regular ht., monel
MS17829-17830 	Nut, self-locking, nylon insert, 250°, regular ht., cres. Steel, steel
MS19067-19068 	Nut, plain, round, retaining
MS20341 	Nut, electrical, plain, hex.
MS20364 	Nut, self-locking, 250 °F, thin
MS20365 	Nut, self-locking, 250° F, regular
MS20501 	Nut, plate, self-locking, two lug
MS21025 	Nut, castellated bearing, retaining

TABLE 7-13. (CONTINUED)









Nut Part Number	Description
MS21047-21048 	Nut, self-locking, plate, two lug, low ht.
MS21049-21050 	Nut, self-locking, plate, two lug, 100° csk., low ht.
MS21051-21052 	Nut, self-locking, plate, one lug, low ht.
MS21053-21054 	Nut, self-locking, plate, one lug, 100° csk.
MS21055-21056 	Nut, self-locking, plate, corner, low ht.
MS21057-21058 	Nut, self-locking, plate, corner, 100° csk.
MS21059-21060 	Nut, self-locking, plate, two lug, floating, low ht.
MS21061-21062 	Nut, self-locking, plate, floating low ht., one lug
MS21069-21070 	Nut, self-locking, plate, two lug, low ht., reduced rivet spacing
MS21071-21072 	Nut, self-locking, plate, one lug, low ht., reduced rivet spacing
MS21073-21074 	Nut, self-locking, plate, corner, reduced rivet spacing

TABLE 7-13. (CONTINUED)





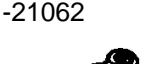
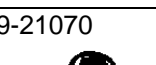
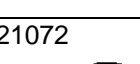





Nut Part Number	Description
MS21078 	Nut, self-locking, plate, two lug, nylon insert
MS21080 	Nut, self-locking, plate, one lug, nylon insert
MS21081 	Nut, self-locking, plate, corner, nylon insert
MS21083 	Nut, self-locking, hex., nylon insert
MS21340 	Nut, plain, hex., electrical, thin, wire holes
MS21917 	Nut, sleeve coupling, flareless
MS21921 	Nut, sleeve coupling, flareless
MS24679-24680 	Nut, plain cap, low & high crown
MS25082 	Nut, plain, thin, hex., electrical
MS27040 	Nut, plain square
MS27128 	Nut, plain, welding

TABLE 7-13. (CONTINUED)









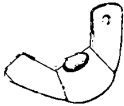

Nut Part Number	Description
MS27130-27131 	Nut, blind, rivet, flathead., open and closed end
MS27151 	Nut, stamped
MS27955 	Nut, spanner, plain, round
MS35425-35426 	Nut, wing, plain & drilled
MS35649-35650 	Nut, plain hex.
MS35690-35691 	Nut, plain hex.
MS35692 	Nut, slotted hex.
MS51967-51972 	Nut, plain, hex.
MS90415 	Nut, self-locking, 12 point captive washer
MS172236-172270 	Nut, spanner, bearing, retaining
MS172321-172370 	Nut, spanner

TABLE 7-13. (CONTINUED)











Nut Part Number	Description
NAS395-396 	Nut, U type
NAS443 	Nut, self-locking, int. wrenching
NAS444-445 	Nut, double lug, anchor type, offset
NAS446 	Nut, flat type
NAS447-448 	Nut, plate, self-locking
NAS449 	Nut, anchor type
NAS450 	Nut, plate, self-locking
NAS463 	Shim, plain anchor nut
NAS487 	Nut, instrument mount
NAS500 	Shim, anchor nut, csk.
NAS509 	Nut, drilled

TABLE 7-13. (CONTINUED)

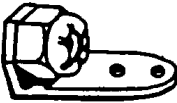



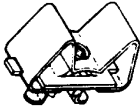





Nut Part Number	Description
NAS577-578 	Nut, self-locking floating barrel retainer
NAS671 	Nut, plain hex., small pattern
NAS680-681 	Nut, plate, self-locking, two lug
NAS682-683 	Nut, plate, self-locking, one lug
NAS684-685 	Nut, plate, corner, self-locking
NAS686 	Nut, plate, self-locking, two lug, floating
NAS687 	Nut, plate, self-locking, one lug
NAS688-695 	Nut Assembly, self-locking, gang channel
NAS696 	Nut, plate self-locking, one lug, miniature
NAS697 	Nut, plate, self-locking, two lug, miniature
NAS698 	Nut, plate, corner, self-locking, miniature

TABLE 7-13. (CONTINUED)











Nut Part Number	Description
NAS1021-1022 	Self-locking Nut, hex., regular and low ht.
NAS1023-1024 	Nut, plate, self-locking, two lug
NAS1025-1026 	Nut, plate, self-locking, one lug
NAS1027-1028 	Nut, plate, corner, self-locking
NAS1029-1030 	Nut, plate, self-locking, one lug, two lug
NAS1031 	Nut, plate, self-locking, two lug, floating
NAS1032 	Nut, plate, self-locking, one lug, floating
NAS1033 	Nut, plate, right angle, floating, self-locking
NAS1034-1041 	Nut Assembly, self-locking, gang channel
NAS1067 	Nut, plate, self-locking, one lug, miniature
NAS1068 	Nut, plate, floating, self-locking, two lug, miniature

TABLE 7-13. (CONTINUED)









Nut Part Number	Description
NAS1098 	Nut, tube fitting
NAS1287-1288 	Nut, hexagonal, self-locking, nut and washer shear pin
NAS1291 	Nut, hexagonal, self-locking, low height
NAS1329 	Nut, blind rivet, flathead, internal thread
NAS1330 	Nut, blind rivet, csk. Head, internal thread
NAS1408-1409 	Nut, hexagonal, self-locking, regular height, coarse and fine thr.
NAS1410 	Nut, tube fitting
NAS1423 	Nut, plain, thin hex., drilled jamnut
NAS1473 	Nut, plate, self-locking, two lug, cap floating
NAS1474 	Nut, plate, self-locking, two lug, cap floating, reduced rivet spacing
NAS1512-1513 	Nut, plate, self-locking gang channel

TABLE 7-13. (CONTINUED)

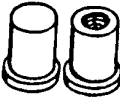
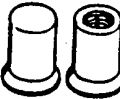
Nut Part Number	Description
NAS8679 	Nut, self-locking, low height 550 °F, 800 °F

TABLE 7-14. TABLE OF WASHERS.









Washer Number	Description
AN935 	Washer, lock, spring
AN936 	Washer, tooth lock
AN950 and 955 	Washer, ball socket, ball seat
AN960 	Washer, flat
AN961 	Washer, flat electrical (Brass, silver or tin-plated)
AN970 	Washer, flat, wood
AN975 	Washer, flat
AN8013 	Washer, insulator
AN122576-122600 	Washer, plain steel

TABLE 7-14. (CONTINUED)





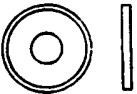





Washer Number	Description
MS9081 	Washer, key dbl. Bearing retaining
MS9274 	Washer, key, dbl. Bearing ret. Cres.
MS9276 	Washer, key, cres. AMS 5510 180° locking
MS9320-9321 	Washer, flat AMS 6350 and 5510
MS9482 	Washer, flat, steel AMS 6437 or AMS 6485 diffused nickel cad. Csk
MS9549 	Washer, flat, AMS 5510
MS9581 	Washer, key, cres. AMS 5510 90° locking
MS9582 	Washer, key, cres. AMS 5510 270° locking
MS9684 	Washer, cup, lock cres. AMS 5510
MS9768 	Washer, flat, cres. AMS 5525 and AMS 5737 csk.
MS9880 	Washer, cup, lock cres. AMS 5510

TABLE 7-14. (CONTINUED)

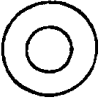



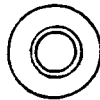





Washer Number	Description
MS9952 	Washer, cup, lock, spanner nut, cres. AMS 5646
MS15795 	Washer, flat, metal
MS17811 	Washer, thrust, steel
MS19069-19070 	Washer, key, retaining
MS20002 	Washer, plain, csk., hi-strength
MS21258 	Washer, key, retaining, steel
MS25081 	Washer, key
MS27051 	Washer, slotted
MS27111 	Washer, finishing, countersunk
MS27129 	Washer, finishing, csk., 80°, 82°
MS27183 	Washer, flat, round

TABLE 7-14. (CONTINUED)











Washer Number	Description
MS28777 	Washer, hydraulic, packing backup
MS35333-35334 	Washer, lock, flat internal tooth, light and heavy
MS35335-35336 	Washer, lock, flat and csk., external tooth
MS35337-35340 	Washer, lock, med., light, heavy
MS35790 	Washer, lock, 100° csk., ext. tooth
MS122026-122075 	Washer, lock spring
MS172201-172235 	Washer, key, single bearing, retaining
MS172271-172320 	Washer, key, single
NAS70 	Washer, plain
NAS143 	Washer, csk. and plain
NAS390-391 	Washer, finishing

TABLE 7-14. (CONTINUED)

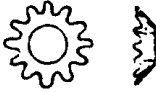







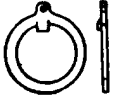

Washer Number	Description
NAS460 	Washer, tab type
NAS513 	Washer, rod end locking, steel
NAS549 	Washer, flat, resin fiber
NAS620 	Washer, flat, reduced O.D.
NAS1061 	Washer, hi-temp, lock, spring
NAS1099 	Washer, bevel 9 1/2°
NAS1169 	Washer, dimpled 100°
NAS1197 	Washer, flat, 5052 aluminum
NAS1252 	Washer, flat
NAS1401 	Washer, radius, al. Alloy, steel, cres. Steel
NAS1515 	Washer, plastic and rubber

TABLE 7-14. (CONTINUED)





Washer Number	Description
NAS1587 	Washer, 1200 °F, plain and csk.
NAS1598 	Washer, sealing
NAS1636 	Washer, key dual tab
NAS1640 	Washer, lock, spring, nonmagnetic

TABLE 7-15. TABLE OF PINS.





Pin Number	Description
AN253 	Pin, hinge
AN380 & 381 	Pin, cotter
AN385 	Pin, plain taper
AN386 	Threaded taper pin
AN392-406 	Pin, flathead
AN415 	Pin, lock

TABLE 7-15. (CONTINUED)



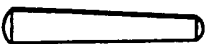
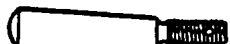
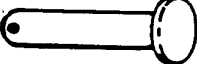

Pin Number	Description
AN416 	Pin, retaining safety
AN122676-122775 	Pin, dowel steel
AN121601-121925 	Pin, flathead clevis .125 -.500 drilled shank
AN150201-150400 	Pin, lock, steel, brass
MS9047 	Pin, spring, steel, phoshated finish
MS9048 	Pin, spring, steel, cadmium plate
MS9105 	Pin, lock
MS9164 	Pin, straight, steel, headless, oversize
MS9245 	Pin, cotter, cres. AMS 7211
MS9389 	Pin, straight, headless, lock, AMS 5735
MS9390 	Pin, straight, headless, cres. AMS 5735, dowel std. & O.S.

TABLE 7-15. (CONTINUED)



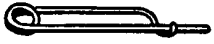
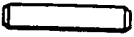
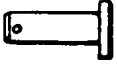

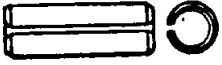
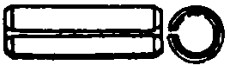

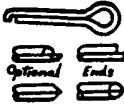
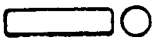
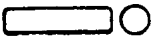
Pin Number	Description
MS9462-9468 	Pin, straight hd. AMS 5735
MS9486 	Pin, straight, headless, lock, AMS 5132
MS9842-9848 	Pin, straight, headed, AMS 5616
MS16555 	Pin, straight, headless .0002 over nominal size
MS16556 	Pin, straight, headless .001 over nominal size
MS16562 	Pin, spring, tubular, slotted
MS17984-17990 	Pin, quick release, positive lock
MS20253 	Pin, hinge
MS20392 	Pin, straight, headed, drilled
MS24665 	Pin, cotter
MS35671-35679 	Pin, grooved, headless, tapered groove

TABLE 7-15. (CONTINUED)

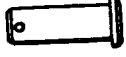

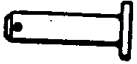
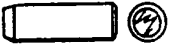
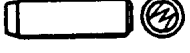

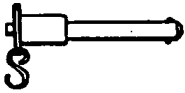
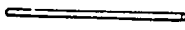
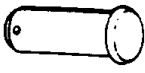
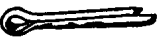

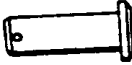

Pin Number	Description
MS35810 	Pin, clevis, headed
MS39086 	Pin, spring, tubular coiled
MS51923 	Pin, spring, tubular coiled
MS51987 	Pin, tubular coiled
MS171401-171900 	Pin, spring, SS, steel
NAS427 	Pin, pulley guard, steel, al. Alloy
NAS561 	Pin, spring slotted and coiled, heavy duty
NAS574 	Pin, rear mounting
NAS607 	Pin, headless, dowel, steel
NAS1292-1296 	Pin, shear thread 100° flush head
NAS1322 	Pin, shear thread, protruding head

TABLE 7-15. (CONTINUED)



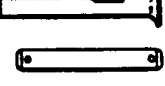

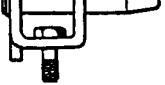

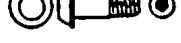

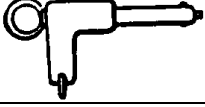
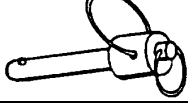

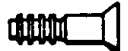
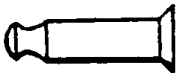
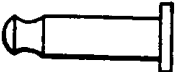
Pin Number	Description
NAS1332-1346 	Pin, quick release
NAS1353-1366 	Pin, quick release, positive locking, double acting
NAS1407 	Pin, spring, coiled
NAS1436-1442 	Pin, swage lock, 100° shear head, pull type, steel
NAS1446-1452 	Pin, swage lock, protruding head, pull type, steel
NAS1456-1462 	Pin, swage lock, 100° head, pull type, steel
NAS1465-1472 	Pin, swage lock, protruding head, pull type, steel
NAS1475-1482 	Pin, swage lock, 100° head, pull type, steel
NAS1486-1492 	Pin, swage lock, 100° head, stump type, steel
NAS1496-1502 	Pin, swage lock, protruding head, stump type, steel
NAS1525-1532 	Pin, swage lock, protruding head, al. alloy

TABLE 7-15. (CONTINUED)

Pin Number	Description
NAS1535-1542 	Pin, swage lock, 100° hd., tension, pull type, alum.
NAS1546-1552 	Pin, swage lock, 100° hd., tension, stump type, alum.
NAS1583 	Pin, 100° csk. hd., hi-shear rivet, 1200 °F
NAS1584 	Pin, flathead, hi-shear rivet, 1200 °F

7-196.—7-206. [RESERVED.]